

RALLY SPEEDWAY



RALLY SPEEDWAY



John Anderson's
RALLY SPEEDWAY

Published by

Adventure International
A Division of
Scott Adams, Inc.

P.O. Box 3435, Longwood FL 32750
Copyright 1983 by Scott Adams, Inc.

All Rights Reserved
(305) 862-6917

User's Manual by Mark S. Murley

Focus. Unwavering and total. Think of it as raw concentration torched up to liquid-fire intensity, and then cooled and hammered out into an unyielding veneer of determination. Think of it as The Edge. No race has ever been won without The Edge and no race ever will.

This race won't be any different.

John Anderson's RALLY SPEEDWAY

We provide the thrills, you provide the skills with John Anderson's RALLY SPEEDWAY, a full-color car-racing simulation guaranteed to rev out hours of fun-injected action for one or two players! Race on the course provided with the game, or create your own with RALLY SPEEDWAY's unique "Trax-Construct" feature.

PLAYING RALLY SPEEDWAY

The objective of RALLY SPEEDWAY is to maneuver one or two joystick-controlled cars through a grueling course as quickly as possible without crashing.

RALLY SPEEDWAY's uniqueness is due, in part, to its "toy-like" design. Just as toy race cars can "jump the track" if the controlling driver isn't careful, likewise, your RALLY SPEEDWAY racer can leave the track and possibly crash into one of the many trees or houses that line the course.

RALLY SPEEDWAY may be played in either of two ways: A single-car game that challenges one player to beat the clock, or a two-car game that pits player against player.

REQUIRED EQUIPMENT

An ATARI 400, 600XL, 800XL, 800 or 1200 Home Computer with at least 16K of memory and a compatible joystick are all you need to play RALLY SPEEDWAY. You'll also need an ATARI Cassette Recorder or ATARI Disk Drive if you wish to save tracks to tape or disk for later play.

LOADING RALLY SPEEDWAY

ATARI 400: Turn on your ATARI Home Computer. Insert the RALLY SPEEDWAY cartridge firmly into the cartridge slot, located on top of the system. Close the top; you will hear a "click" when it's properly closed.

ATARI 600XL and ATARI 800XL: Turn off your ATARI Home Computer. Insert the RALLY SPEEDWAY cartridge into port at the top of the system. Turn the computer on.

ATARI 800: Turn on your ATARI Home Computer. Insert the RALLY SPEEDWAY cartridge firmly into the left cartridge slot, located on the top of the system. Close the top; you will hear a "click" when it's properly closed.

ATARI 1200: Insert the RALLY SPEEDWAY cartridge firmly into the cartridge slot, located on the left-hand side of the computer chassis. Turn on your ATARI Home Computer.

ALL SYSTEMS: Connect one ATARI-compatible joystick to your ATARI Home Computer for one player, or two joysticks for two players. Two joysticks are required if you wish to use the "Trax-Construct" feature.

THE OPTION AND TITLE SCREENS

The Title screen will appear once the RALLY SPEEDWAY cartridge is inserted and your ATARI is turned on. The screen will read:

JOHN ANDERSON'S RALLY SPEEDWAY
COPYRIGHT 1983 BY
ADVENTURE INTERNATIONAL
ALL RIGHTS RESERVED

This screen will alternate with the Option screen (shown below) until an option is selected.

The Option screen lists the available game choices in the order shown below.

RALLY SPEEDWAY OPTION SCREEN

START THE RACE

ONE PLAYER
TWO PLAYER

DRY ROADS
WET ROADS
ICY ROADS

REAL LIFE
ONLY IN A COMPUTER

TOP SPEED = 100 MPH
TOP SPEED = 80 MPH

Screen continues
on next page

TOP SPEED = 60 MPH
TOP SPEED = 40 MPH

SLOW ACCELERATION
NORMAL ACCELERATION
FAST ACCELERATION

LOAD TRAX
MAKE TRAX
SAVE TRAX

RESET BEST L/T

SELECTING AN OPTION

Use the joystick handle to move the pointing "finger" to the desired option. Press the joystick trigger button to select. Note: START THE RACE should be the last option selected.

An explanation of each item on the Option screen follows.

START THE RACE - Clears Option screen; Starting Line and car(s) will appear. Move the joystick handle to begin play for a one-player game. Two-player start: The Blue-car driver must press the joystick handle to begin play. Select START THE RACE after other options are chosen.

ONE PLAYER - Select solo game. Objective is to race the course as quickly as possible.

TWO PLAYER - Select two-player game. Objective is to beat your opponent to the finish line with the lowest time.

DRY ROADS - Select normal road conditions. Cars will have maximum control on curves and hairpins.

WET ROADS - Select wet road conditions. Cars will lose some control on curves and hairpins.

ICY ROADS - Select icy road conditions. Cars will have minimum of control on curves and hairpins.

REAL LIFE - Select realistic driving conditions. Obstacles such as grass, water, houses, and trees will affect car movement.

ONLY IN A COMPUTER - Renders obstacles harmless. Cars may negotiate entire playing area without crashing.

TOP SPEED 40/60/80/100 - Select desired maximum car speed.

SLOW/NORMAL/FAST ACCELERATION - Select desired acceleration.

LOAD/MAKE/SAVE TRAX - See Part II — RALLY SPEEDWAY TRAX-CONSTRUCT FEATURE for more information.

RESET BEST L/T - Reset Best Lap Time. Returns the Best Lap-Time counter to 00.00.00 in a one-player game.

CHOOSING A COURSE — ONE AND TWO PLAYER GAME

Two separate race tracks are provided with your RALLY SPEEDWAY cartridge (shown in Figure 1, below). To choose a track, move the pointing finger to MAKE TRAX on the Option screen and press the joystick button. The track that appears is Track 1. Choose Track 2 by pressing **SELECT**. Press **START** to return to the Option screen. The track chosen will appear when START THE GAME is selected.

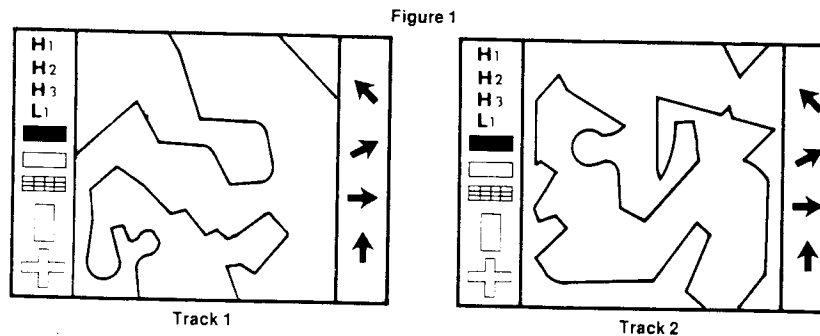

GAME SUMMARY - ONE-PLAYER GAME

After START THE GAME is selected from the Option screen, the race course will appear. The player's car will be positioned on the Starting Line (shown in Figure 2 below). The player will control the Blue car with the joystick that is attached to CONTROLLER JACK 1.

The Starting Line (also called the Lap Counter) is distinguished from the rest of the track by a cluster of red arrows. The arrows, which are located on the Starting Line itself, indicate the direction that the player's car will move during the game. Your car will appear on the Starting Line when START THE RACE is selected from the Option screen. Moving the joystick handle starts the race.

The object of a one-player game is to move around the track and across the finish line as quickly as possible. Your time will be displayed during the race in the lower left portion of the screen.

Figure 2

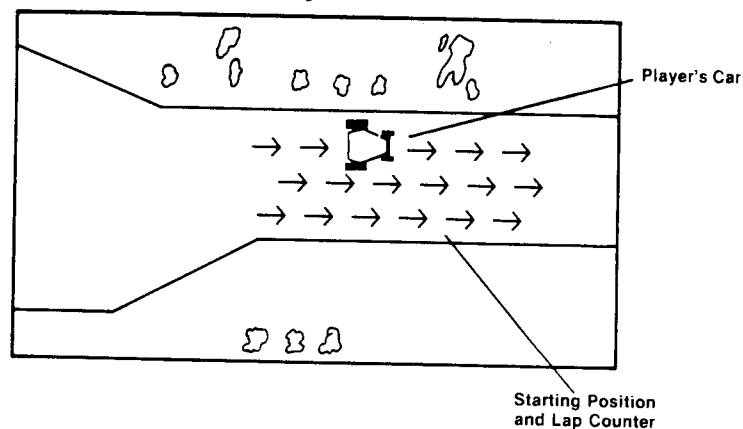

THE JOYSTICK

RALLY SPEEDWAY features two different styles of joystick control, SETTING 1 and SETTING 2.

SETTING 1

SETTING 1, which automatically initiates when your ATARI is turned on, gives the player control over his car FROM THE CAR'S PERSPECTIVE. This means that pressing the joystick to the right (the 3 o'clock position) turns the car to its right regardless of the car's position on the screen (see Figure 3). Pressing the joystick to the left (the 9 o'clock position) turns the car to its left, and so on.

SETTING 1 Neutral Position

The joystick handle in SETTING 1 position is largely designed to rest in the "neutral" position during play. As your car moves around the track, a quick press of the joystick handle should be sufficient to correct your car's direction. Several games may be required for you to get the "feel" of the joystick. The Information Bar at the bottom of the screen will feature black letters when SETTING 1 is engaged.

SETTING 2

SETTING 2 moves the car relative to the joystick itself. For example, pressing the joystick handle to the right moves the car to screen right, regardless of the car's screen position (see Figure 3). Engage SETTING 2 by pressing **SELECT** at any time during play. The Information Bar at the bottom of the screen will feature inverse letters when SETTING 2 is engaged.

The joystick trigger button has a dual function in both SETTING 1 and SETTING 2 — it controls the braking action and also acts as an "increased steering control" when the player is negotiating sharp curves. By pressing the joystick button, the rate at which the car will turn increases. Press and release to slow the car; press and hold to bring the car to a complete stop.

Figure 3

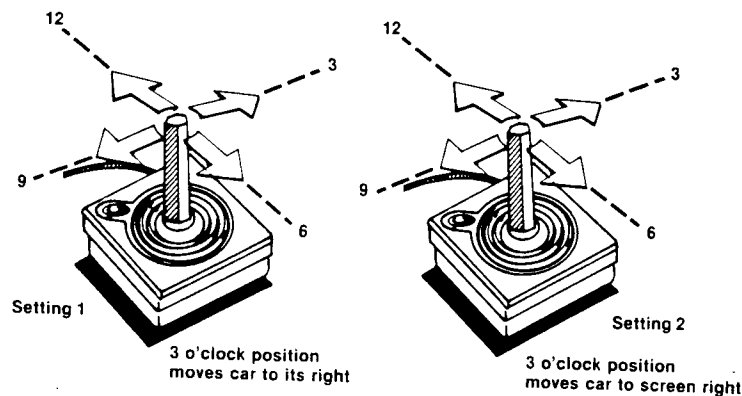

INFORMATION BAR

The Information Bar contains important game information including lap count and a running clock. The contents of the Information Bar will vary from a one- and two-player game.

The Information Bar, as it appears in one- and two-player games, is shown below. Sample information is included.

INFORMATION BAR — One Player Game

L/T 02:23:8	LAST 02:57:9	BEST 01:59:0
-------------	--------------	--------------

From left to right, the information represents:

L/T 02:23:8 — Current lap time: Two minutes, twenty-three and eight-tenths seconds.

LAST 02:57:9 - Lap time of the last race: Two minutes, fifty-seven and nine-tenths seconds.

BEST 01:59:0 - Best lap time so far: One minute, fifty-nine seconds.

INFORMATION BAR - Two Player Game

TIME 04:31

LAP 02

TIME 04:23

From left to right, the information represents:

TIME 04:31 — Player One, current time: Four minutes, thirty-one seconds.

LAP 02 — A two-lap game is in progress.

TIME 04:23 — Player Two, current time: Four minutes, twenty-three seconds. Player Two is trailing his opponent by 8 seconds.

GAME SUMMARY — TWO-PLAYER GAME

After START THE GAME is selected from the Option screen, the race course and cars will appear. The player using the joystick connected to CONTROLLER JACK 1 will drive the Blue car; the player using the joystick connected to CONTROLLER JACK 2 will drive the Red car.

CHOOSING THE NUMBER OF LAPS

Press **OPTION** to increase the number of laps to be raced. Press and hold **OPTION** while tapping **SELECT** to return the lap setting to one. If **OPTION** is not pressed, the lap setting will default to a 3-lap game.

STARTING THE RACE

The Blue-car driver begins the game by pressing the joystick handle. The lap timer begins running at this time as well.

PENALTIES

A penalty is assessed against a player if the following occurs during play: (1) His car leaves the track and strikes an object; (2) an opponent outdistances him (lagging); (3) an opponent beats the player to the Start/Finish line (except for the final lap).

CRASHING

If a player's car leaves the track and strikes a house or a tree, a 10-second penalty is assessed.

A player's car will catch fire if a crash occurs. The car's "driver" will leap from the burning car, roll several times, and then stand and wave to indicate that all is well. The other player's car disappears

during this animated segment. After the crashed driver has demonstrated his continued good health, both cars will reappear on the track. The Blue-car driver must then press the joystick handle for the race to continue.

A car may appear to graze a house or a tree and not crash. This is normal.

LAGGING

If one of the player's cars should outdistance the other car to the point that the faster car leaves the screen area, the word **PENALTY** will appear on the side of the screen of the player who was penalized. Furthermore, a 5-second penalty will be assessed against the slower car. Both cars will be reset side by side and the race will continue when the Blue-car driver presses the joystick handle.

CROSSING THE FINISH LINE

When the leading car passes the finish line (lap counter), the trailing car is penalized 5 seconds except during the final lap of a game when no penalty is assessed. During the final lap, the finish line acts as a tie breaker.

PAUSING A GAME

Press any key on your ATARI to pause the game. The engine sounds will continue in the Pause mode, and the perimeter of the Information Bar will change to blue as a reminder that Pause is engaged.

RETURNING TO THE OPTION MENU

Press **START** any time during play to return to the Option screen.

COURSE HAZARDS AND OBSTACLES

Houses, orchards, trees, grass, water hazards . . . you'll find the scenery to be interesting — and occasionally deadly — throughout the entire RALLY SPEEDWAY course. A brief explanation of the roadside sights follows.

GRASS — "Grows" just about everywhere. A car that has run off onto the grass will slow dramatically until it returns to the track.

HOUSES — Usually found very close to the track. Striking a house adds 10 seconds to the offending car's lap time.

LAKES — Small bodies of water. Slows car movement to an even greater degree than does grass.

ORCHARDS — Tree clusters. As with the houses, avoid contact. 10-second penalty incurred for striking one.

GAME SOUNDS

The sounds of RALLY SPEEDWAY are more than decorative; they provide important information during the game.

There are two types of "informative" sounds in RALLY SPEEDWAY: low- and high-pitched bell sounds. The information conveyed by the sounds depends upon the number of game players.

ONE PLAYER-LOWER "DING" — Heard during a second or subsequent lap. Indicates that the player will NOT beat his best recorded lap time to date.

ONE PLAYER-HIGHER "DING" — Indicates that the player has passed the lap counter.

TWO PLAYER-LOWER "DING" — Penalty sound for Pink car.

TWO PLAYER-HIGHER "DING" — Penalty sound for Blue car.

ENGINE SOUNDS — A "non-informative" sound. Heard at all times during play, even when the game is paused.

RALLY SPEEDWAY — PLAYING TIPS

- Stay behind the other car whenever possible. This will give you more time to react.
- Use light taps on the joystick handle to adjust your car's direction whenever on the straightaways.
- Try to negotiate corners with a minimum of skidding. The more severe a skid is, the longer it takes to regain full acceleration.
- Typically, bumping an opponents' car will cause your car to lose control instead of the other person's. However, a well-timed bump into your opponent's rear while entering a corner may send your opponent into a fiery crash.
- Joystick SETTING 1 offers the most control and is the preferred control option for experienced racers. SETTING 2 is fine for players who may find SETTING 1 difficult, or who enjoy a little variety now and then.

- The Fast Acceleration option tends to reduce penalties from lagging. Conversely, the Slow Acceleration option tends to increase penalties.

- Don't be afraid to race on Wet and Icy roads. Even beginners may find these options more enjoyable at lower speeds.

PART II — RALLY SPEEDWAY

TRAX-CONSTRUCT FEATURE

WHAT IS THE "TRAX-CONSTRUCT FEATURE"?

The Trax-Construct feature is an optional way for you to design your own RALLY SPEEDWAY race tracks. Once a new track is created, it can be stored to tape or disk and reloaded for future play.

WHAT WILL I NEED TO USE THE TRAX-CONSTRUCT FEATURE?

You will need two ATARI-compatible joysticks, and an ATARI Cassette Player or ATARI-compatible disk drive. You'll also need at least one extra blank cassette or disk, depending on the system employed. The Trax-Construct feature may be used even if you don't have a cassette or disk system; however, any tracks created will be "lost" when your ATARI is turned off.

IS IT DIFFICULT TO DESIGN MY OWN TRACK?

Not at all. You will find, though, that a little practice is required to easily identify the various track sections. For this reason, be sure to carefully examine the illustrated TRACK ELEMENTS sections.

HOW THE TRAX-CONSTRUCT WORKS

The TRAX-CONSTRUCT begins with a special screen that represents the total race track area. This screen acts in much the same way as does a table top for an unassembled jigsaw puzzle. The "pieces" of track are selected and placed onto the Trax screen. Once all of the pieces are in place, the track can be saved in its entirety to tape or disk for future play.

HOW MANY RALLY SPEEDWAY TRACKS CAN BE SAVED ONTO A TAPE OR DISK?

18 tracks can be saved onto a single disk. With a cassette, the number will depend on the length of the tape. Cassette users will find it much more convenient to save one or two tracks onto a short (C-10 or C-20) cassette than filling a C-90 with dozens of tracks. (We recommend saving one track and a backup to each side of a cassette.)

CONNECTING THE JOYSTICKS

Two ATARI-compatible joysticks will act as controls for the Trax-Construct process. Connect them to your ATARI Home Computer at this time. From this point on, the joystick connected to Port 1 will be referred to as JOYSTICK 1, and the Port 2 joystick as JOYSTICK 2.

ACCESSING THE "MAKE TRAX" SECTION

After loading RALLY SPEEDWAY as per instructions outlined at the beginning of this manual, you will see the Option screen. Use JOYSTICK 1 to move the pointing "finger" to MAKE TRAX. Press the JOYSTICK 1 trigger button; the Trax screen will appear as in Figure 4 below.

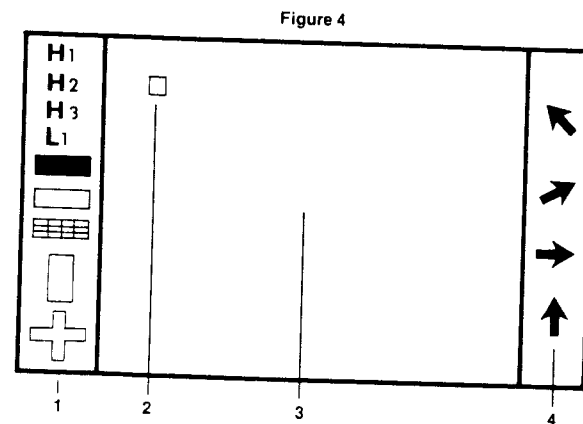

THE TRAX SCREEN EXPLAINED

The Trax screen is made up of four important parts. These include:

- 1) The TRACK ELEMENT COLUMN. This is located in the far left side of the screen area.
- 2) The COURSE area itself. This corresponds to the actual race track used during a game.
- 3) The CURSOR, a movable, on-screen reference that lets you designate where a track element is to be placed.
- 4) The DIRECTION ARROWS, which determine the direction in which a crashed car is reset.

JOYSTICK FUNCTIONS

Virtually all Trax-Construct work is accomplished with your two ATARI joysticks. The handle of JOYSTICK 1 controls the movable cursor; the button "lays" the track piece selected. The handle of JOYSTICK 2 scrolls the column of track elements; the button selects the correct Direction Arrow set.

TRACK LAYOUT THEORY

Creating a new track involves two major steps: (a) Scrolling the column of track elements (located to the left of the Trax screen) so that the "piece" to be laid appears in the small window; and (b) placing the cursor on the course area where the track piece is to be placed.

TRACK ELEMENT COLUMN

The Track Element column contains representations of the various obstacles, track sections, and scenery that can be placed onto the Course area. We'll refer to each "piece," regardless of its function, as an element. You'll find the Track Element column on the far left side of the Trax screen.

Although the actual track elements are not numbered on your screen, you can match what you see with their numbered counterparts in Figure 6 of this manual. This will simplify your understanding of what each element is used for and which track element pieces can and cannot be attached to one another.

THE COURSE AREA — Erasing An Existing Course

When MAKE TRAX is first selected from the Option screen, the first of two race tracks provided with RALLY SPEEDWAY will appear in the large, square area that dominates most of the screen. Press **SELECT** to toggle between the two tracks.

You can substitute a full screen of any of the track elements by pressing **OPTION**. (We suggest using the blank element, grass, which appears when the MAKE TRAX screen is first selected.) This will "erase" any existing track layout or track elements, giving you a clean screen onto which your course can be built.

When **OPTION** is pressed, the element appearing in the Trax Element column window will fill the course area. For example, if **OPTION** is pressed and H1 appears in the Trax Element Window, the entire course area will fill with H1 (Type 1 Houses).

THE CURSOR

Press the handle of JOYSTICK 1 to move the cursor about the course area. A special "wraparound" effect causes a cursor that has disappeared at the screen's edge to reappear at the opposite side of the screen. This allows quick recovery of the cursor, and lets you lay wraparound track for more interesting track configurations.

THE DIRECTION ARROWS

Sooner or later, your car will meet a fiery demise on some tortuous hairpin. After the figurative smoke clears, your car (or both cars in a two-player game) will be reset in one of two directions: either the way you've come or the way you were going. Each piece of track that is laid must be "programmed" to correctly reset any cars which crash on it. This is the function of the Direction Arrows, located to screen right.

There are two sets of Direction Arrows, named, appropriately enough, SET 1 and SET 2. SET 1 resets a crashed car in a Northwest, Northeast, East or North direction. SET 2 resets in a Southeast, Southwest, West or South direction. To change sets, press the button on JOYSTICK 2, or the **SPACEBAR**.

Using the Direction Arrows

To correctly use the Direction Arrows, simply make sure that the set appearing on your screen has an arrow pointing in the direction you wish your car to be reset after a crash. (See Figure 5 below.)

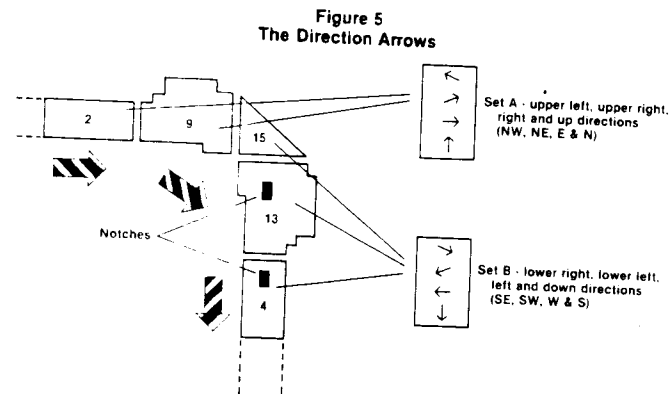

The Striped Arrows indicate the direction the car(s) is moving. From left to right, TE 2 corresponds to the third arrow in Set A; therefore a car crashing here would reject facing right. TE 9, likewise. TE 15 begins a downward in any element indicates that Set B is engaged. Press the joystick button to toggle to Set B, and lay TE 15. The notch therefore, TE 15 and 13 should be laid while Set B is engaged.

THE TRACK ELEMENTS

Each track element that appears in the Track Element column is reproduced below. Study each piece carefully. Although each track element is numbered here, you will have to match the representations here with their un-numbered, on-screen counterparts. Each piece listed here is numbered between 1 and 21, plus an additional eight elements that represent objects such as lakes and trees. TE 3, for example, is Track Element 3, the lap counter. Use the JOYSTICK 2 handle to scroll the Track Element column.

Figure 6

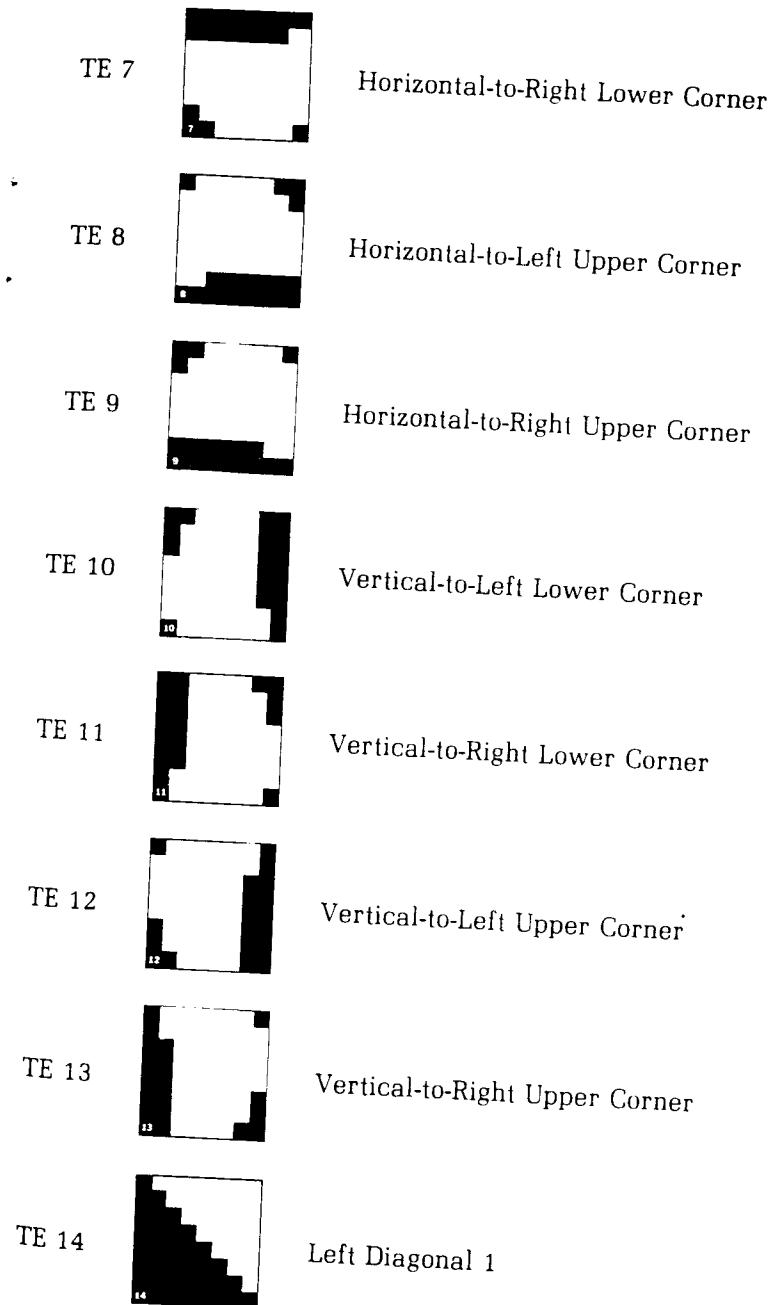
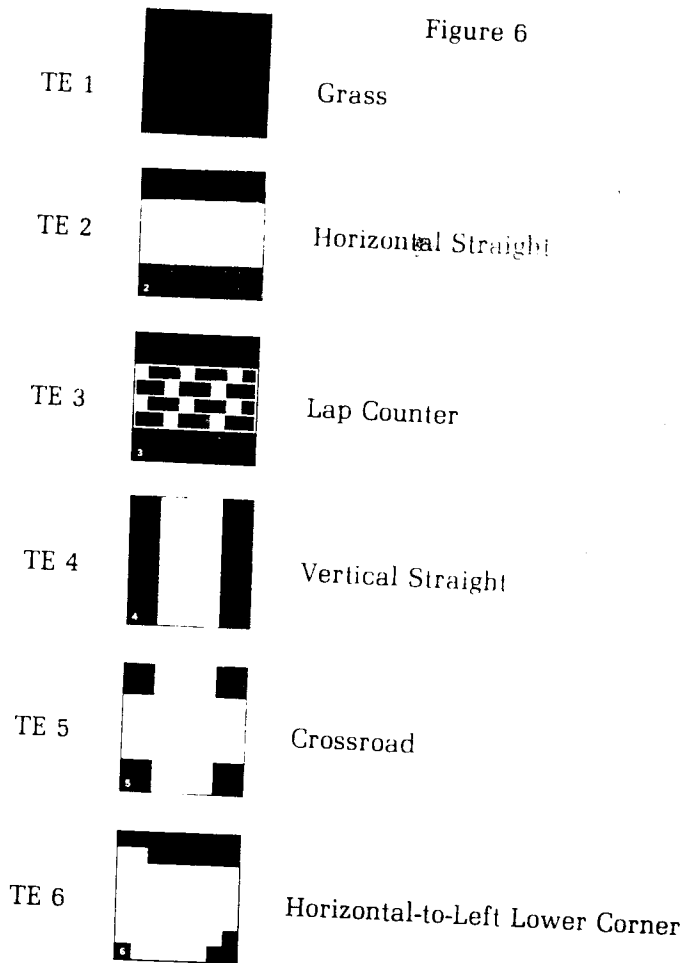

TE 15



Left Diagonal 2

TE 16



Right Diagonal 1

TE 17

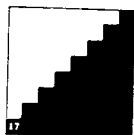

Right Diagonal 2

TE 18



Right Hairpin

TE 19



Left Hairpin

TE 20



Lower Hairpin

TE 21



Upper Hairpin

TE O



Orchard

TE T1



Tree 1

TE T2



Tree 2

TE T3

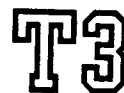

Tree 3

TE H1



House 1

TE H2



House 2

TE H3



House 3

TE L1



Lake 1

Some RALLY SPEEDWAY users may find a "shortcut" method useful in designing their tracks. On the opposite side of this page, twenty of the primary Track Elements have been reproduced. Follow the steps below.

1. Make several photocopies of the Track Element side of this page.
2. Using a pair of scissors, cut out each individual Track Element.
3. You can now place the Track Elements together and physically "shuffle" them until a pleasing design is discovered. Figure A, below, shows the arrangement of Track Elements 2, 5, 7, 17 and 11 into a workable track segment.

Figure A

