



TM

Operation, Maintenance and Service Manual

Complete with Illustrated Parts Lists

GAME SERIAL NUMBER LOCATION

Your game's serial number is printed on a label on the outside back of the cabinet. The same number is also printed on a label on the chassis of the video display, power supply, Regulator/Audio II Printed Circuit Board (PCB), and the game PCB. Please mention this number when calling your distributor for service.

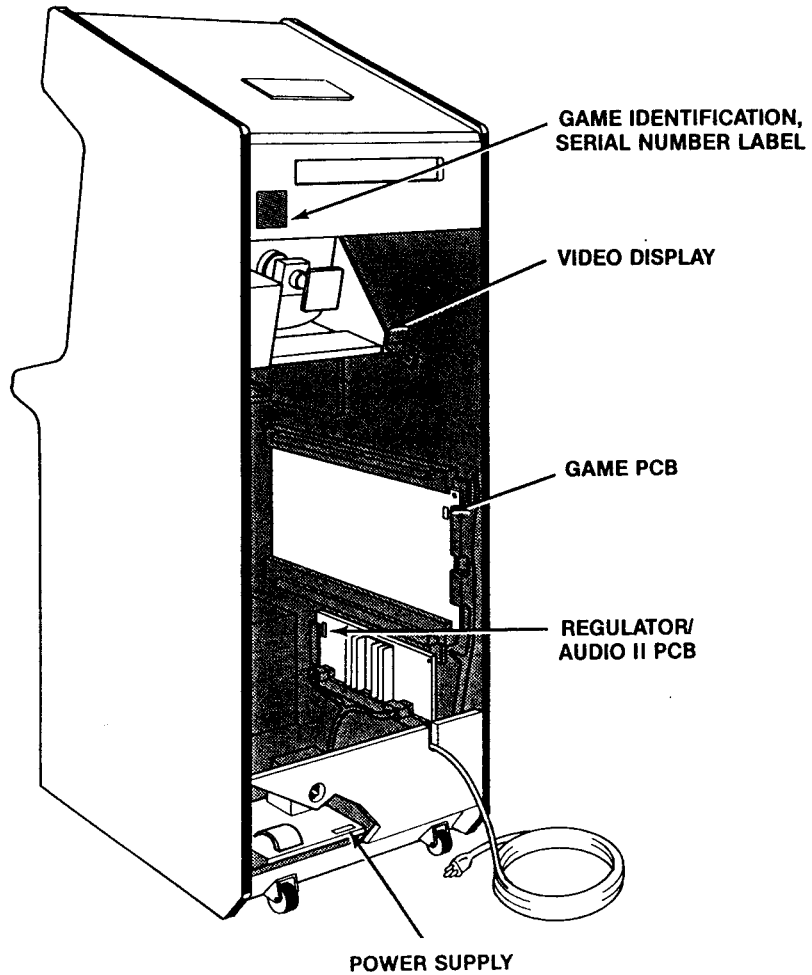

TM-206
1st printing

Operation, Maintenance and Service Manual

Complete with
Illustrated Parts Lists



GRAVITAR™

Table of Contents

1 Set-Up Procedures

A. New Features	1-3
B. Game Inspection	1-3
C. Game Installation	1-3
1. Installation Requirements	1-3
2. Voltage Selection	1-3
D. Switch Locations	1-4
1. On/Off Switch	1-4
2. Utility Panel Switches	1-4
3. Option Switches	1-4
E. Option Switch Settings	1-5
F. Self-Test Procedure	1-7
G. Game Play	1-9
1. Demonstration Mode	1-9
2. Attract Mode	1-9
3. Play Mode	1-10
4. High-Score Mode	1-11
5. Hints for Game Play	1-11

2 Troubleshooting

A. Comments on Troubleshooting	2-2
B. Self-Test Procedure	2-2

3 Maintenance, Repair and Parts

A. Cabinet-Mounted Assemblies	3-2
B. The Control Panel	3-4
C. Fluorescent Tube and Speaker	3-6
D. Video Display	3-8
E. Coin Door	3-10
F. Printed-Circuit Boards	3-13
G. Power Supply Assembly	3-21

List of Illustrations

Figure 1-1	Game Overview	1-2
Figure 1-2	Game Switch Locations	1-4
Figure 1-3	Operator Information Display	1-7
Figure 2-1	Self-Test Screen 1—Test Passes	2-2
Figure 2-2	Self-Test Screen 1—Test Fails	2-3
Figure 2-3	Self-Test Screen 2	2-3
Figure 2-4	Self-Test Screen 3	2-4
Figure 2-5	Self-Test Screen 4	2-4
Figure 2-6	Self-Test Screen 5	2-4
Figure 2-7	Self-Test Screen 6	2-4
Figure 2-8	Screen 7: Self-Test Screens During Signature Analysis	2-5
<i>Maintenance, Repair and Parts:</i>		
Figure 3-1	Cabinet-Mounted Assemblies	3-2
Figure 3-2	Control Panel	3-4
Figure 3-3	Control Panel Assembly	3-5
Figure 3-4	Fluorescent Tube and Speaker	3-6
Figure 3-5	Video Display	3-8
Figure 3-6	Vertically Mounted Coin Door	3-10
Figure 3-7	Printed-Circuit Board (PCB) Removal	3-13
Figure 3-8	Gravitar Game PCB Assembly	3-14
Figure 3-9	Regulator/Audio II PCB Assembly	3-19
Figure 3-10	Power Supply Assembly	3-21

List of Tables

Table 1-1	Game Price Options	1-5
Table 1-2	Special Options	1-5
Table 1-3	Game Play Options	1-6
Table 1-4	Self-Test Procedure	1-8
Table 1-5	Gravitar High-Score Lists	1-9
Table 1-6	Gravitar Scoring	1-11

Set-Up Procedures

How to Use This Manual

This manual, written for game operators and service technicians, describes the Gravitar™ game.

Chapter 1 describes new features, game setup, option switch settings, self-test procedures, and game play.

Chapter 2 contains troubleshooting procedures.

Chapter 3 details maintenance, repair, and parts information.

In addition, schematic diagrams of the game circuitry are included with this manual.

Figures 1-1 and 3-1 illustrate the game cabinet. Italicized lettering on these figures refers you to other places in the manual for information about specific cabinet parts.

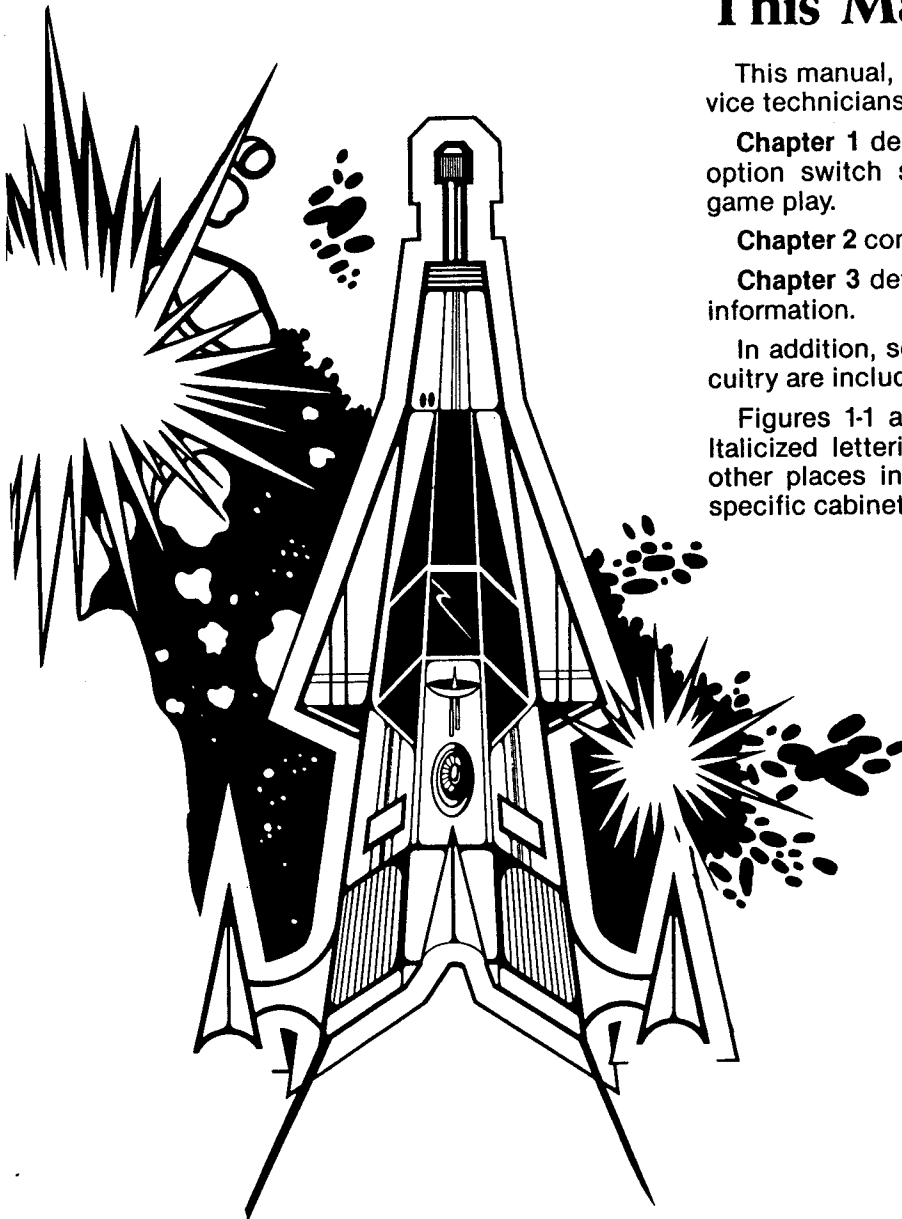

Chapter

1

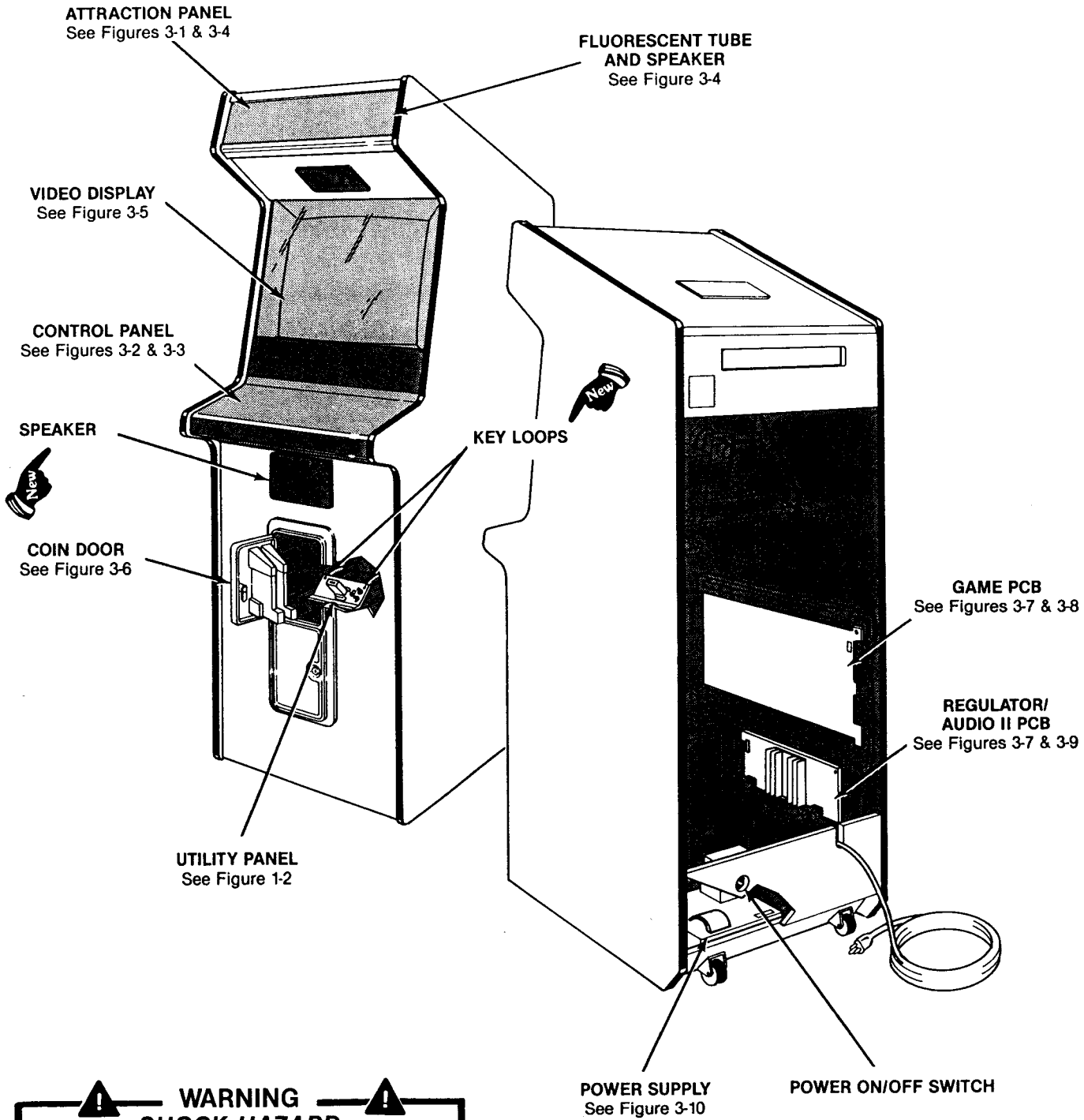

WARNING
SHOCK HAZARD

Connect this game only to a grounded 3-wire outlet. If you have only a 2-wire outlet, we recommend you hire a licensed electrician to install a grounded outlet. *Players may receive an electric shock if this game is not properly grounded!*

Figure 1-1 Game Overview

A. New Features

The Gravitar™ game has four new features. Even if you are familiar with ATARI® games, you should note these important differences:

1. **Shielded Game Speakers.** These 8-ohm, 6-ounce, high-fidelity speakers provide exceptional audio. The speaker magnets are shielded.
2. **Key Loops.** The utility panel has two key loops. They provide a convenient place to store keys for the rear access panel and lower coin door.
3. **High-Score Table.** There are eight different titles for the high-score table. The title is determined by the highest score registered (see *G. Game Play*).
4. **Molded Coin Box.** This game has a sleek, one-piece molded coin box with handles on either end for easier carrying.

New features and all other major parts in the game are illustrated in Figure 1-1. Throughout this manual, wherever one of these new features is mentioned, you will see this symbol:



B. Game Inspection

Please inspect your game carefully to ensure that it was delivered to you in good condition.

NOTE

Do not plug in the game yet!

1. Examine the exterior of the game cabinet for dents, chips, or broken parts.
2. Remove the screws that were used as extra security to seal the rear access panel. Unlock and open this panel and the coin door; inspect the interior of the game as follows:
 - a. Ensure that all plug-in connectors (on the game harness) are firmly plugged in. Replug any connectors found unplugged. **Don't force connectors together.** The connectors are keyed so they only fit in the proper orientation. **A reversed edge connector may damage a PCB** and will void your warranty.
 - b. Ensure that all plug-in integrated circuits on the PCB are firmly plugged into their sockets.
 - c. Remove the tie-wrap that secures the coiled power cord inside the cabinet. Inspect the

power cord for any cuts or dents in the insulation. Repair or replace it as required. Place the square black plastic strain-relief plate in the wood slot at the bottom of the rear panel opening.

WARNING

To avoid electrical shock, do not touch internal parts of the display with your hands or with metal objects held in your hands!

- d. Note the game serial number. It is printed on a label on the back of the cabinet. Verify that the same serial number is also on the Gravitar game PCB, Regulator/Audio II PCB, power supply, and video display. A drawing of the serial-numbered components is on the inside front cover of this manual. Please mention this number whenever you call your distributor for service.
- e. Inspect major subassemblies, such as the power supply, control panel, and video display, for secure mounting.

C. Game Installation

1. Installation Requirements

Power	200 W
Temperature	0 to 38°C (32 to 100°F)
Humidity	Not over 95% relative
Space Required	64 x 80 cm (25 ½ x 31 ½ in.)
Game Height	184 cm (72 ½ in.)

2. Voltage Selection

The power supply used in this game operates on the line voltage of almost any country in the world. The power supply comes with either one, two, or three different voltage selection plugs. Plug voltages and wire colors are 100 VAC (violet wire color), 120 VAC (yellow wire color), 220 VAC (blue wire color), and 240 VAC (brown wire color).

Before plugging in your game, check your line voltage. Then check the wire color on the voltage selection plug that is plugged into your power supply. Make sure the voltage selection plug is correct for your location's line voltage (see *Figure 3-10*).

D. Switch Locations

1. On/Off Switch

The on/off switch is located on the back of the cabinet, lower left side (see *Figure 1-2*).

2. Utility Panel Switches

The utility panel includes the volume control, self-test switch, coin switch, and coin counter(s). The coin switch is used to credit the game, and it acti-

vates the left coin counter. These switches are located inside the upper coin door (see *Figure 1-2*).

3. Option Switches

Option switches are located on the game PCB (see *Figure 1-2*).

- a. Game price options are at PCB location B4.
- b. Game play options are at PCB location D4.
- c. Special options are at PCB location P10/11.

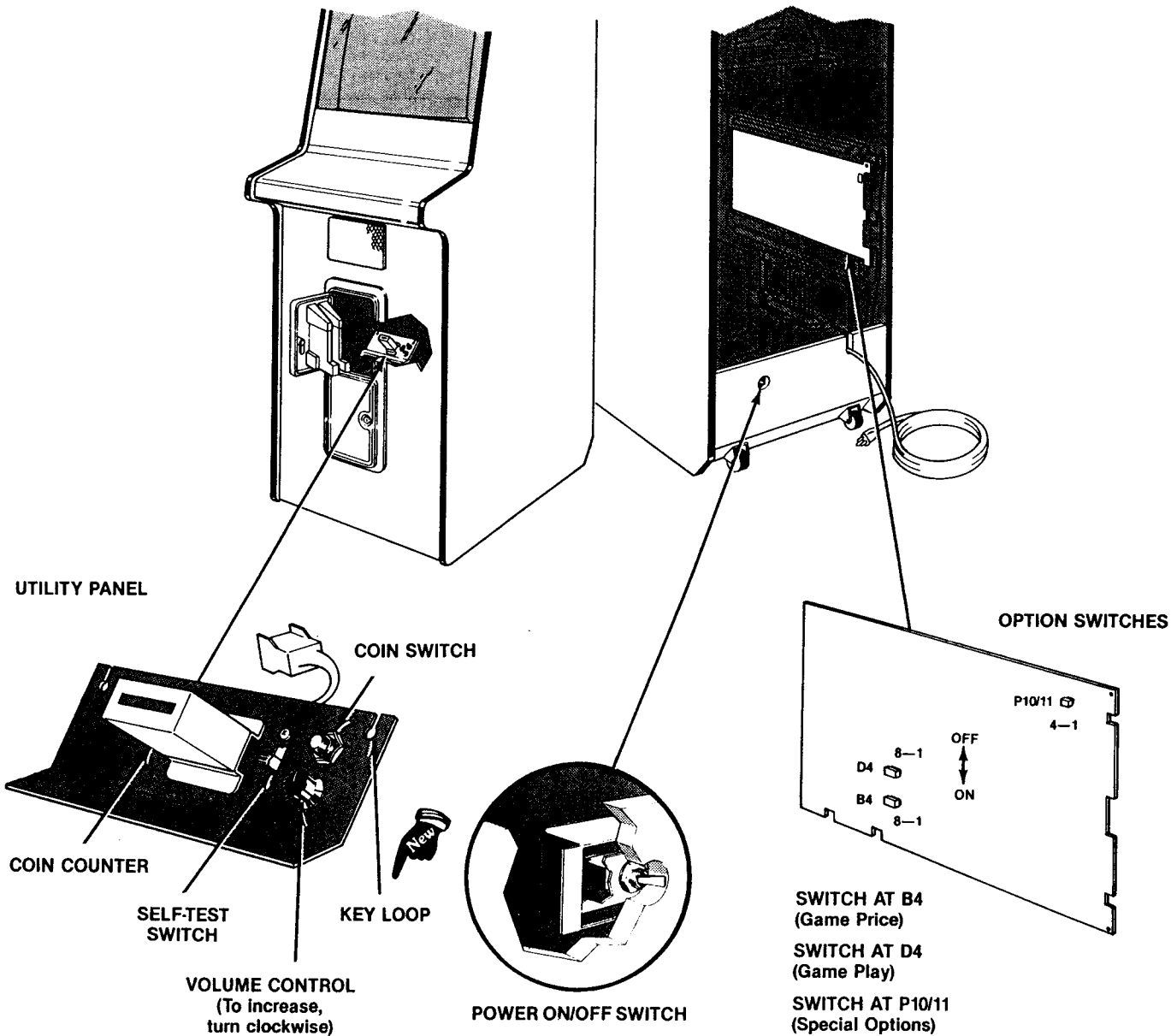

Figure 1-2 Game Switch Locations

E. Option Switch Settings

Tables 1-1, 1-2, and 1-3 detail game option switch settings. Options are preset at the factory and shown by the ◀ symbols. However, you may change the settings to suit your individual needs.

To verify option switch settings, power the game *off* and then *on* again. Set the self-test switch to *on* and verify the settings on the self-test screen. Then set the self-test switch to *off*.

Table 1-1 Game Price Options

This table contains the switch settings for options relating to game price, coin mechanism multipliers, and bonus play. The switches are on the game PCB at location B4 and are accessible when the game PCB is mounted in place.

The *coin mechanism* is a device on the inside of the coin door that inspects the coin to determine if the correct coin has been inserted. After this inspection, the mechanism either accepts or rejects the coin.

The *multipliers* (toggles 4-6) determine how much each coin mechanism will be worth to the game's logic. The coin door has two mechanisms.

The basic unit of measurement is a coin worth \$.25 or 1 DM, which equals a multiplier of x1. Therefore, if you have a 2 DM/1 DM coin door, you may want to set the left multiplier at x2 and the right multiplier at x1.

You may offer *bonus play* for certain combinations of coins inserted. For example, with the game set at \$.25 per play, players who deposit four successive quarters, then press the start switch, can receive a bonus play. The bonus feature encourages players to insert more money than just the minimum \$.25 required for one game. All coins must be inserted before pressing the start switch.

Settings of 8-Toggle Switch on Gravitar PCB (at B4)								Option
8	7	6	5	4	3	2	1	
Off	On							Free play
On	On							1 coin for 2 credits
Off	Off							1 coin for 1 credit ◀
On	Off							2 coins for 1 credit
		Off	Off					Right coin mechanism x 1 ◀
		On	Off					Right coin mechanism x 4
		Off	On					Right coin mechanism x 5
		On	On					Right coin mechanism x 6
				Off				Left coin mechanism x 1 ◀
				On				Left coin mechanism x 2
					Off	Off	Off	No bonus coins ◀
					Off	On	Off	For every 4 coins inserted, logic adds 1 more coin
					On	On	Off	For every 4 coins inserted, logic adds 2 more coins
					Off	Off	On	For every 5 coins inserted, logic adds 1 more coin
					On	Off	On	For every 3 coins inserted, logic adds 1 more coin
					Off	On	On	No bonus coins
					On	On	On	No bonus coins

◀ *Manufacturer's recommended settings*

Table 1-2 Special Options

Settings of 4-Toggle Switch on Gravitar PCB (at P10/11)				Option
4	3	2	1	
			On	Credits counted on one coin counter.
			Off	Credits counted on two separate coin counters

Table 1-3 Game Play Options

This table contains the switch settings for options relating to game difficulty, language, bonus, and ships. The switches are on the game PCB at location D4, and are accessible when the game PCB is mounted in place.

Settings of 8-Toggle Switch on Gravitar game PCB (at D4)								Option		
8	7	6	5	4	3	2	1			
Not used	Not used			On	Not used	On	On	No bonus		
						Off	Off	Bonus ship every 10,000 points ◀		
						On	Off	Bonus ship every 20,000 points		
						Off	On	Bonus ship every 30,000 points		
Not used	Not used			Off	Not used			Easy game play ◀		
										Hard game play
								Off	Off	3 ships per game
								On	Off	4 ships per game ◀
		Off	On					5 ships per game		
		On	On					6 ships per game		

◀Manufacturer's recommended settings



F. Self-Test Procedure

This game will test itself and provide data to show that the game's circuitry and controls are operating properly. The data is provided on the video display and speaker. No additional equipment is necessary.

We suggest you perform the self-test procedure when you first set up the game, any time you collect money from the game, when you change game options, or when you suspect game failure.

Wait at least 10 seconds after playing a game before entering self-test. Otherwise you may erase

the top three scores in the high-score table or distort the statistics. All credits will be cancelled when you enter self-test.

Refer to *Figure 1-2* for the location of the self-test switch and option switches. To see the Operator Information Display, set the self-test switch to *on* (see *Figure 1-3*). To enter self-test, hold the FIRE button down while pressing 1-player start (see *Figure 1-4*). To end the self-test, set the self-test switch to *off*.

The complete self-test procedure is explained in *Chapter 2, Self-Test Procedure*. If a part of the test described in *Figure 1-4* fails, refer to *Chapter 2*.

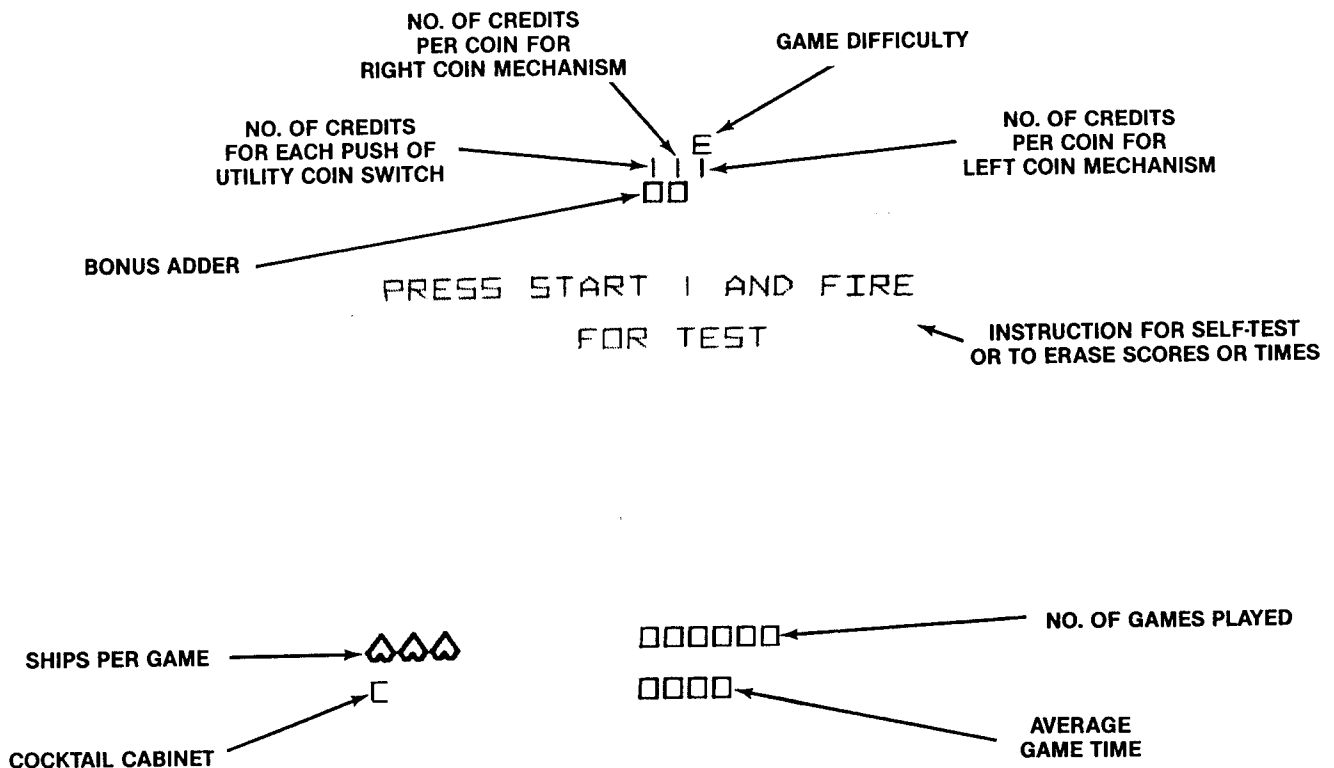

Figure 1-3 Operator Information Display

The Operator Information Display shows game statistics. You may also erase game scores and times. To see this display, set the self-test switch to *on*.

To erase game scores:

1. Push 1-PLAYER START until display reads **PRESS START 1 AND FIRE TO CLEAR SCORES**.
2. Press both FIRE and 1-PLAYER START.
3. The word **ERASING** flashes on the screen until the entire table is erased. Wait until the word **ERASING** disappears before going on with other tests.

To erase game times:

1. Push 1-PLAYER START until display reads **PRESS START 1 AND FIRE TO CLEAR TIMES**.
2. Press both FIRE and 1-PLAYER START.
3. The word **ERASING** flashes on the screen until the entire table is erased. Wait until the word **ERASING** disappears before going on with other tests.

To erase game scores and times:

1. Push 1-PLAYER START until display reads **PRESS START 1 AND FIRE TO CLEAR TIMES AND SCORES**.
2. Press both FIRE and 1-PLAYER START.
3. The word **ERASING** flashes on the screen until the entire table is erased. Wait until the word **ERASING** disappears before going on with other tests.

To end the Operator Information Display, set the self-test switch to *off*.

Table 1-4 Self-Test Procedure

Instruction	Test Passes
1. Set the self-test switch to <i>on</i> . While holding the FIRE button down, press 1-player start.*	The screen shows the self-test display. RAMs, ROMs, and three integrated circuits are tested. If the screen is different from the self-test display, or if there are sounds, refer to <i>Chapter 2, Self-Test Procedure</i> .
2. Activate control panel and coin switches.	As you activate the switches, you should hear a beep and the proper 0 should change to 1. If the test fails, refer to <i>Chapter 2, Self-Test Procedure</i> .
3. Observe the white frame at the sides of the screen.	Each frame corner should be within 1/4-inch of each display bezel corner. If the test fails, refer to <i>Chapter 2, Self-Test Procedure, Screen 2</i> .

*All credits are cancelled when you enter self-test

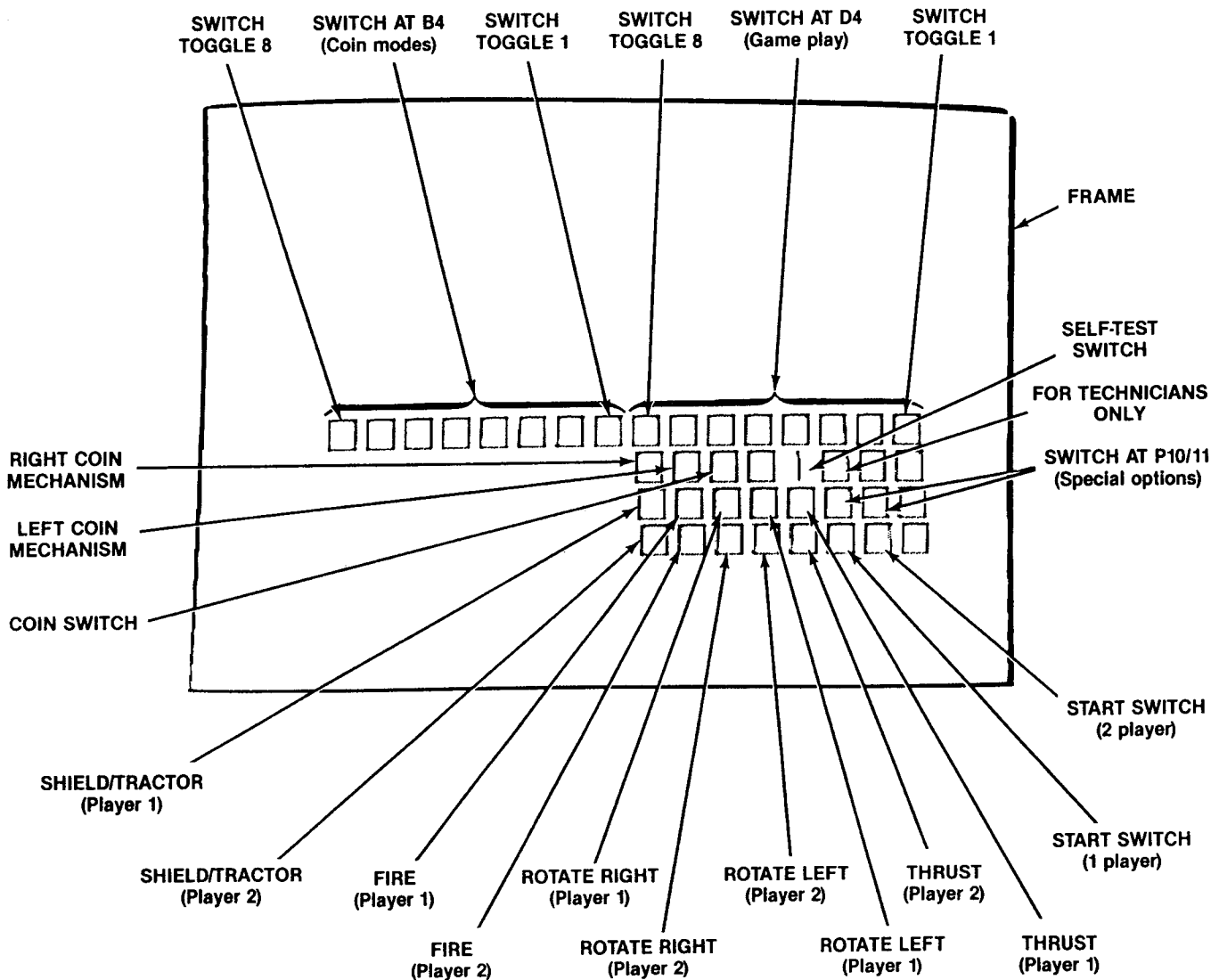

Figure 1-4 Self-Test Display

G. Game Play

Gravitar™ is a one- or two-player game with a color X-Y video display. This new display, with its 3 color guns and higher voltage, has the same technology that was used in previous Atari black-and-white X-Y displays. However, the screen now displays dazzling colors and unique visual effects.

The player controls a space ship in three different solar systems. Each solar system consists of a home base, a death star, a red alien planet and four regular planets. Each planet has its own unique terrain.

The red alien planet is the home of shooting alien ships. Some of the regular planets may have flying alien rammers to be avoided or shot down. The four planets all have fuel cells to be retrieved with a tractor beam and alien bunkers that fire shells. Successfully destroying all of the bunkers results in a MISSION COMPLETE message at the top of the screen. Achieving MISSION COMPLETE allows the player to collect bonus if he can evade the rammers when leaving the planet. If successful, he will be placed back in the solar system.

A player has two ways to advance to the next solar system. The first is to successfully complete a mission on all four regular planets. The second way is to complete a mission on the red alien planet, which establishes a link into the next solar system.

Gravitar™ has five possible modes of operation: demonstration, attract, play, high-score, and self-test. Self-test is a special mode for checking the game switches and computer functions. You may enter self-test at any time. Wait at least ten seconds after a game has been played before entering self-test or turning off power; otherwise, you may erase the high-score table.

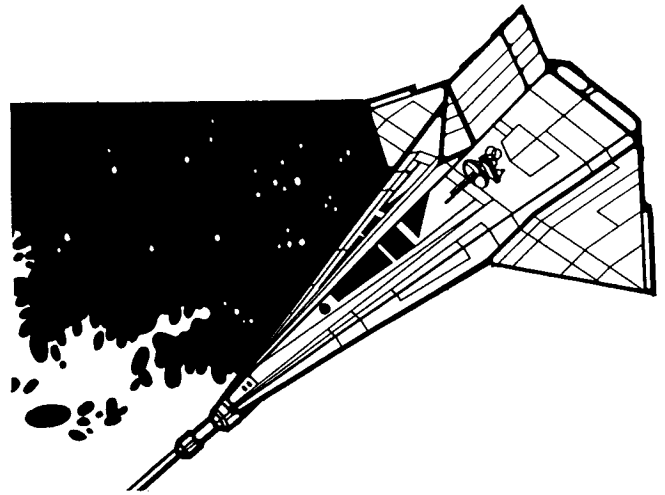

1. Demonstration Mode

The demonstration mode allows the operator to enter all planets to see their respective terrains and obstacles without being destroyed by shots from bunkers or alien space ships, or being hit by flying alien rammers. Enter this mode when you are in the *Operator Information Display* (see *Figure 1-3*) by simultaneously pressing all five player control buttons. To end this mode, set the self-test switch to off.

2. Attract Mode

The attract mode begins when power is applied to the game, after a play or high-score mode, or after self-test. This mode repeats every 30 seconds. It ends only when a credit is entered or when self-test begins.

The screen displays one of four possible pictures in this mode. The first picture displays the single-player high-score table for approximately ten seconds. The words SCORE, FUEL, and GAME OVER appear. The words INSERT COIN and the coin mode appear if no coin(s) or not enough coins are inserted. The number of credits may show, if any. During this time the 1-player and 2-player red light-emitting diode (LED) lights flash.

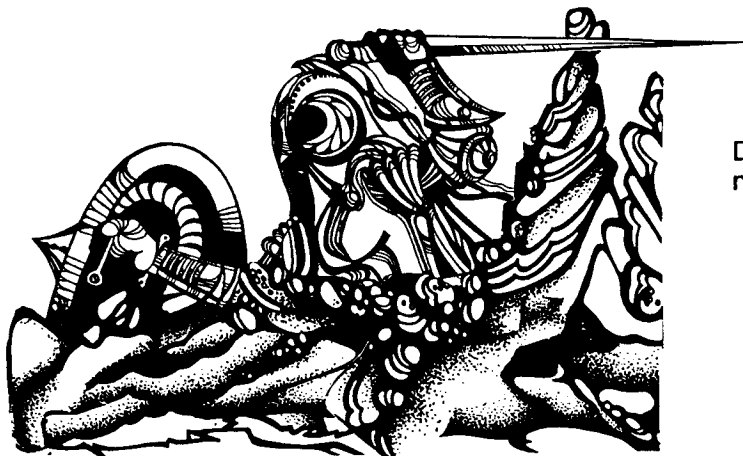
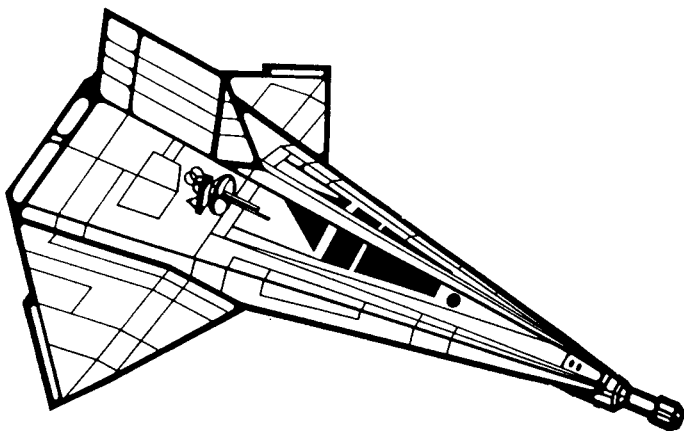

Table 1-5 Gravitar™ High-Score Lists

Depending on the highest score, one of eight list names appears above the table of initials.

Name of List	Points
FLUNKY	0-20,000
GUNNER	20,001-40,000
CO-PILOT	40,001-80,000
PILOT	80,001-100,000
ACE PILOT	100,001-200,000
KILLER PILOT	200,001-400,000
PONTIUS PILATE	400,001-800,000
GOTTA-BE-LUCKY	above 800,000



The second picture spells GRAVITAR in expanding and contracting letters. It lasts approximately nine seconds.

The third picture lasts about two seconds. The screen shows a solar system with a player's blue space ship in the center at home base. All planets and their respective bonus point values are visible. ATARI MCMLXXXII copyright message appears in the center of this picture, and the number of credits (if any). DANGER appears above the death star. The ship flies toward the easiest planet in the upper right part of the screen.

The fourth picture in this mode is a full-screen view of planet terrain with the player's blue space ship appearing at the top center of the screen. The ship travels in the scrolling, zooming terrain until it crashes or is shot down. The words SHOOT BUNKERS, TRACTOR FUEL, SCORE, FUEL, and number of credits (if any) are displayed.

Game play begins when the correct credit(s) is entered and the 1- or 2-player button(s) is pressed.

3. Play Mode

The play mode begins in the first solar system with the player's blue ship in the center of the screen at home base. There are four regular planets plus a fifth red alien planet and a death star arranged clockwise around the screen in increasing order of difficulty. The planets are worth 2,000, 4,000, 6,000, and 8,000 points with a value of 9,000 points on the alien planet. The positions of the alien planet and the death star vary in the second and third solar systems. After the first solar system all planets are valued at 9,000 points. The death star, located near home base, is the center of gravity in each solar system. Colliding with it results in the loss of one life, and the player returns to home base.

The words SCORE (with current total score), FUEL (running total of original 10,000-point fuel supply), and BONUS (decreasing point value of planet under attack) appear at the top of the screen throughout game play.

Player controls consist of LEFT ROTATE, RIGHT ROTATE, FIRE, THRUST, and TRACTOR/SHIELD yellow pushbuttons. Use FIRE to shoot targets. A player has four shells that must hit a target or must travel their full distance in order to be reloaded. TRACTOR/SHIELD retrieves fuel with a tractor beam and shields the ship from alien shots. The TRACTOR/SHIELD does not prevent the ship from crashing into land or alien ships. TRACTOR/SHIELD and THRUST decrease the player's fuel supply. Using these controls together decreases the fuel supply even faster.

Blue fuel cells are positioned just below a planet's surface. There are two, three, or four fuel cells per planet terrain (depending on level of game play). Each cell beamed aboard ship with TRACTOR is worth 2,500 fuel units.

If the player's ship is above the highest point on some planet terrains, flying alien rammers attack him. Shooting a rammer scores 100 points.

If the player gets too close to a shooting alien ship, he is involved in a one-on-one space dogfight, and either he or the alien ship must die. If the player is victorious, he returns to the solar system at his original spot; if the alien ship wins, the player loses a life and returns to home base.

Red alien bunkers appear on each planet. There are two, four, six, or eight bunkers per surface (depending on the difficulty of the planet). The bunkers fire shots to protect the fuel cells. Exploding a bunker scores 250 points. Exploding all bunkers in a solar system displays a MISSION COMPLETE message.

The word SUPERBONUS and the number of superbonus points appear in the middle of the screen only after a completed mission on the first planet in the first solar system. These superbonus points are awarded on the basis of initial difficulty of the first planet successfully completed. The higher the bonus point value of the planet attacked, the higher the superbonus awarded. No superbonus points are awarded for attacking the 2,000-point (easiest) planet or for attacking the four regular planets in consecutive order of difficulty.

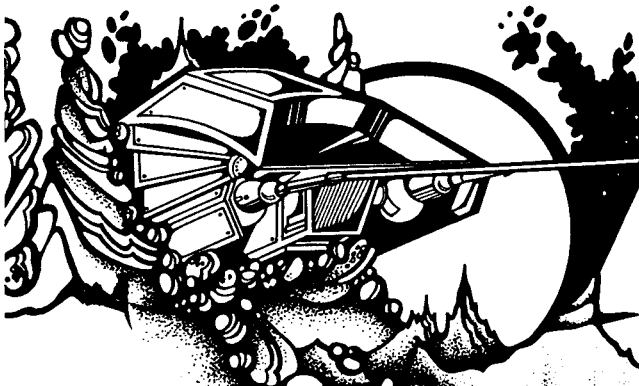

Table 1-6 Gravitar™ Scoring

Planet Bonus*	Superbonus**
9,000	20,000
8,000	12,000
6,000	6,000
4,000	2,000
2,000	0

Obstacles	Points
Red bunker	250
Rammer	100
Alien Ship	100

*Constantly decreases with elapsed game time

**Awarded after first MISSION COMPLETE achieved

A player may fly to any planet he chooses. The number beside each planet is the starting number of bonus points for that planet. Entering a planet causes the distinct planet terrain to appear. To get maximum points, the player must shoot all alien bunkers and see MISSION COMPLETE at the top of the screen. A player may exit a planet at any time; he does not have to stay any longer than he wishes.

The red alien planet (worth 9,000 points) is home for red alien ships that must be shot down or avoided. The alien planet looks the same in every solar system: terrain consists of a spiral tunnel with a reactor at its end. Under a decrementing timer, the player must maneuver through the tunnel without hitting the walls and shoot the reactor. (Hitting the walls or not escaping in time places the player back at home base.) Shooting the reactor will make it glow and pulsate. Then the player must escape before the timer reaches zero. (In the next solar systems, the timer of the alien planet decreases by two seconds, and there are shooting bunkers to overcome.) Completing the mission on the alien planet places the player in the next solar system with an additional 7,500 fuel points.

Gravitar progresses by waves of planets (new solar systems). Successfully destroying the reactor and escaping from the red alien planet, or achieving

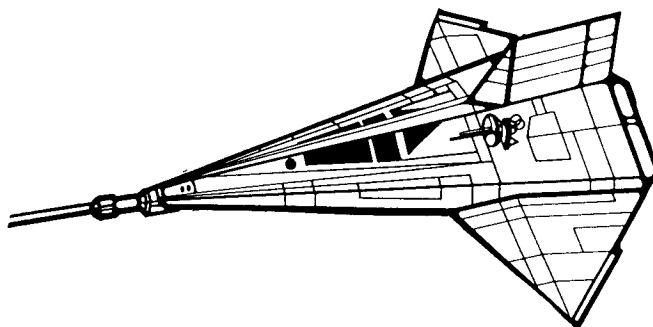

a MISSION COMPLETE on all four regular planets places the player in the next solar system (next level of game play). The four levels of game play are described as follows:

- a. Regular gravity
- b. Negative gravity
- c. Regular gravity with invisible landscape and maximum difficulty
- d. Negative gravity with invisible landscape and maximum difficulty

Alien ship speed and firing frequency, rammer speed, bunker firing frequency, and bonus points are all based on time elapsed in game play. Both regular and negative gravity increase, depending on the initial planet bonus level.

The game ends when all lives are used up or when player is out of fuel. Then the screen briefly displays the words SCORE, FUEL, PLAYER 1 (or 2), GAME OVER.

4. High-Score Mode

This mode begins if a player has earned one of the eight highest scores. The player has one minute to enter his initials. Letters of the alphabet increment with LEFT ROTATE and decrement with RIGHT ROTATE pushbuttons. Select letters with the TRACTOR/SHIELD pushbutton. To reset the high-score table, power the game *off* and then *on*, or enter and end the self-test mode (this does not erase the top three scores).

5. Hints for Game Play

- Develop skill for controlling the space ship in regular and negative gravity.
- Beam up fuel cells with TRACTOR/SHIELD.
- Attack the red alien planet first for maximum challenge and 20,000 bonus points! Completion of this planet immediately places a player in the next solar system where all planets are worth 9,000 bonus points.
- Attack more difficult planets early in the game for higher bonus points.
- Many planet terrains have safe areas or "blind spots" from which the player can safely shoot at bunkers.



Troubleshooting

The page features several stylized, high-contrast black and white explosion or starburst graphics. One is in the upper left, another in the upper right, and a large, complex one in the lower left. A large, stylized number '2' is in the bottom right corner.

This game tests itself when the self-test switch is set to the *on* position. If there is a failure, the game produces audiovisual aids to help you find the failing portion of the game. The self-test procedure included in Chapter 1 will help you decide if the game is or isn't working properly. The expanded self-test procedures in this chapter are included to help the qualified electronic technician troubleshoot the game.

Chapter

2

A. Comments on Troubleshooting

When troubleshooting, first determine the symptom(s) of the failure. After determining the symptom, look over the wiring diagram and determine what assemblies could cause the failure. Could it be caused by the power supply, Regulator/Audio II PCB, or the video display?

The next step is to check all harness wires and connectors to the suspected failing assembly. If you find no harness or connector problem, substitute an assembly known to be good for the suspected failing assembly. If the game functions properly, you have successfully isolated the failure. If it doesn't, repeat the procedure with another assembly.

When you have isolated the failing assembly, you must troubleshoot that assembly and make the necessary repairs. If the video display is failing, we suggest that a qualified video display technician handle the troubleshooting and repair. If the power supply or Regulator/Audio II PCB is failing, troubleshooting and repair are relatively simple, as these assemblies are not too complicated. If a game PCB is failing, troubleshooting and repair depends on your understanding of the operation of the PCB.

To effectively troubleshoot a game PCB, learn as much as you can about the PCB. The diagrams in the *Schematic Package* (included with the game) show the functions of the circuitry. Again, while troubleshooting the PCB, first determine the symptom of the failure, then locate the suspected area on the schematic diagram.

The *Schematic Package* has signatures printed in red at the proper test-node points for PCB memory devices. For example, to determine if the self-test ROM is functioning properly, perform signature analysis with the ATARI® CAT Box. The *Schematic Package* contains a complete description of signature analysis using the CAT Box.

A glossary of schematic signal descriptions is included in the *Schematic Package*. Each signal description states if the signal is hardware- or software-generated, where it is generated, where it goes, and what it does. We suggest you use this glossary to become more familiar with the operation of the game PCB.

B. Self-Test Procedure

To enter Self-Test, set the self-test switch to the *on* position. Press FIRE and then 1-player start. If the test passes, the screen goes blank for a few seconds and then displays the picture below. See *Chapter 1, Section F, Self-Test Procedure* for a complete description of this picture.

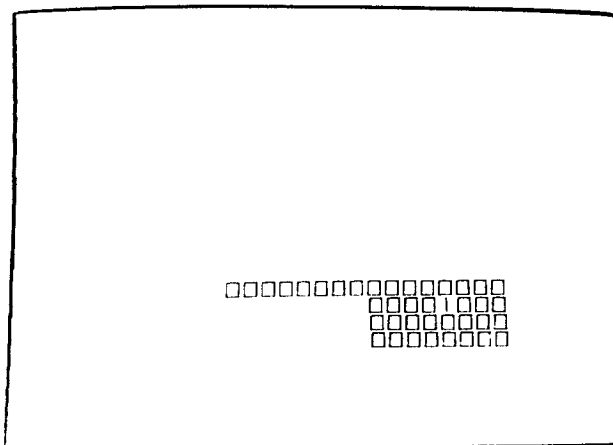

Figure 2-1 Self-Test Screen 1 Test Passes

NOTE

This procedure does not test the coin door lockout coils and coin counter. If the lockout coils do not energize when the game is on, suspect the lockout coil wiring, coin door harness, game PCB harness, latch R9, or driver Q2 of the game PCB. Troubleshoot using the game schematics.

SCREEN 1:

RAM failure is indicated by a sound and, if possible, an *R* displayed in the top center of the screen. Count the tones. One or two tones indicates RAM failure at game PCB location N/P1. Three or four tones indicate RAM failure at game PCB location K7.

Tone	Failing RAM Location on Game PCB
1st or 2nd	N/P1
3rd or 4th	K7

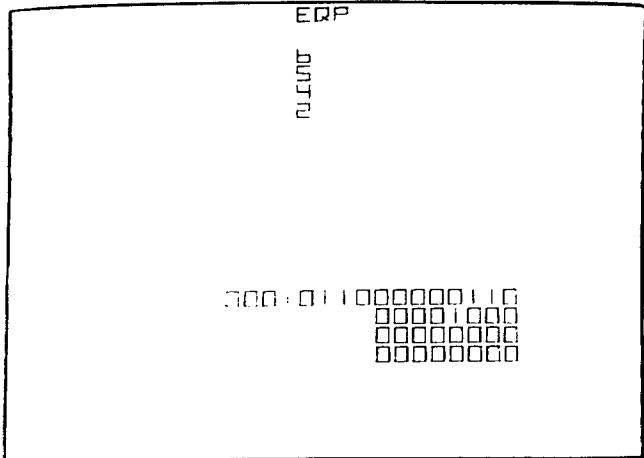

**Figure 2-2 Self-Test Screen 1
Test Fails**

ROM failure is indicated by one or more vertically arranged numbers displayed on the top half of the screen (see *Figure 2-2*). The bad ROM and its location are listed as follows:

Screen Display	Failing ROM Location on Game PCB
0 *	L7
1 *	M/N7
2 *	N/P7
3	R7
4	D1
5	E/F1
6	H1
7	J1
8	K/L1
9 **	M1

*If this ROM is bad you will hear a constant low tone, and the program may be unable to display a screen image.

**If this ROM is bad, the screen may be blank.

EAROM or CUSTOM I/O CHIP failure is indicated by one letter in the top center of the screen. Identify the failure with the table below.

Letter Displayed	Location on Game PCB
E	EAROM at M2
P	Custom I/O chip at C/D3
Q	Custom I/O chip at B3

SWITCH failure is indicated by the associated 0 not changing to a 1 on the screen and no sound when the switch is activated. Troubleshoot using the information in *Chapter 3, Section B*, and game schematics.

SOUND failure is indicated by no sound. Check the volume control levels on the utility panel, or troubleshoot using the game schematics.

To see the remaining self-test screens (2 through 8), press the coin switch on the utility panel for each screen.

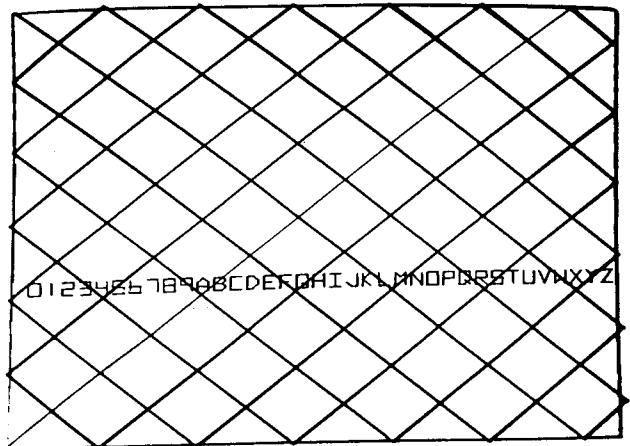
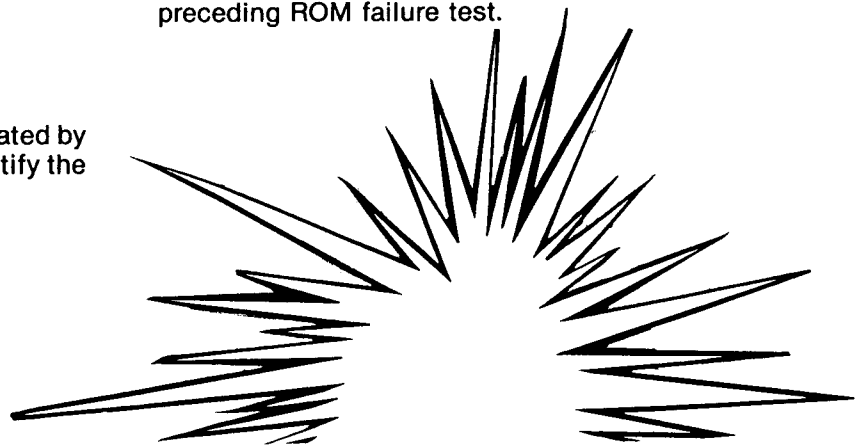

Figure 2-3 Self-Test Screen 2

SCREEN 2:

A white diagonal grid pattern and a complete character set appear on the screen (see *Figure 2-3*). The edges of the grid pattern should touch the sides of the screen. If the display is not centered, symmetrical, or the proper size, adjust the X SIZE, Y SIZE, X CTR, Y CTR, X LIN, OR Y LIN pots on the game PCB (refer to the *Schematic Package*). If the characters are incorrect, check again for a 2 displayed in the preceding ROM failure test.



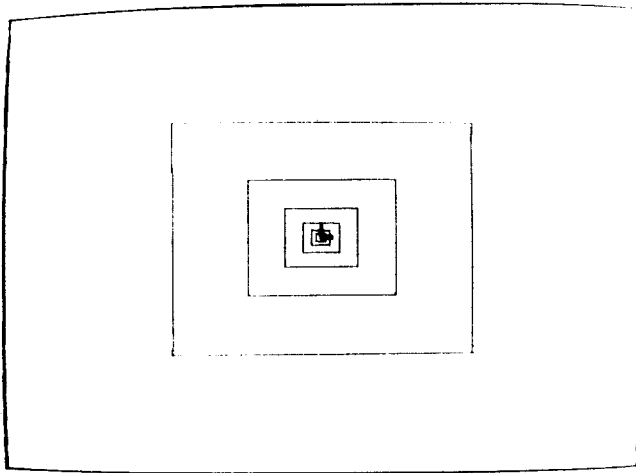

Figure 2-4 Self-Test Screen 3

SCREEN 3:

A white box of decreasing size appears during this test. The box should shrink smoothly. There are seven stages, each with a tone. This pattern tests the binary and linear scaling circuitry. Troubleshoot using the game schematics.

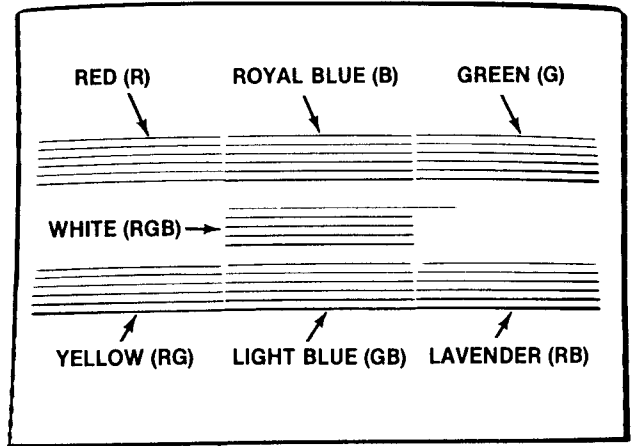

Figure 2-6 Self-Test Screen 5

SCREEN 5:

This test checks the seven screen colors and six intensities of each color (see *Figure 2-6*). If the intensities do not progress from dim at the top of each color group to bright at the bottom, there is a problem in the Z-axis of the game PCB or the video display. Use this pattern for tracking adjustments (refer to the color X-Y display manual).

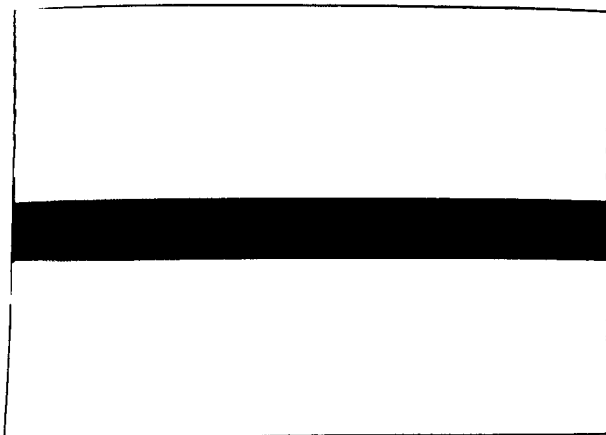

Figure 2-5 Self-Test Screen 4

SCREEN 4:

A series of horizontal lines are visible in the middle of the screen. This is a raster test, used by the manufacturer only, to set the color levels.

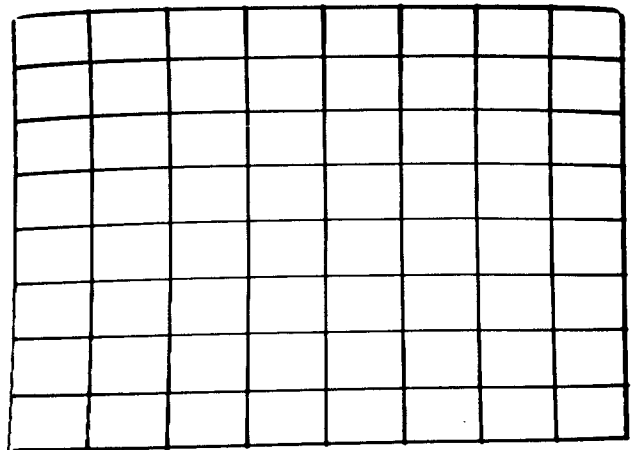

Figure 2-7 Self-Test Screen 6

SCREEN 6:

A grid pattern touches the corners of the video display (see *Figure 2-7*). Press the 1-player start button to change colors. Use this pattern for purity and convergence adjustments (refer to the color X-Y display manual).

VECTOR-GENERATOR DIAGNOSTIC PROGRAM

The diagnostic program is controlled by switches 2, 3, and 4 in the 4-toggle option switch bank at location P10/11 on the game PCB. This group of switches lets you choose one of six tests.

These tests provide recurring sequences to make it easy for you to troubleshoot the vector-generator circuitry. The tests and their respective option switch settings are as follows:

Test	Action	Settings of 4-Position DIP Switch at P10/11		
		4	3	2
Test 1	Press WDDIS every 4 msec (blank screen)	Off	Off	Off
Test 2	Test vector-generator halt instruction every .55 msec (blank screen)	On	Off	Off
Test 3	Test vector-generator long vector (and halt instruction) every 8.2 msec	Off	On	Off
Test 4	Test vector-generator jump instruction (and long vector and halt instruction) every 8.2 msec	On	On	Off
Test 5	Test vector-generator short vector instruction (and all of Test 4) every 8.6 msec	Off	Off	On
Test 6	Test vector-generator JSRL/RTSL instruction (and all of Test 5) every 10.2 msec	On	Off	On
Test 2	Blank screen	Off	On	On
Test 2	Blank screen	On	On	On

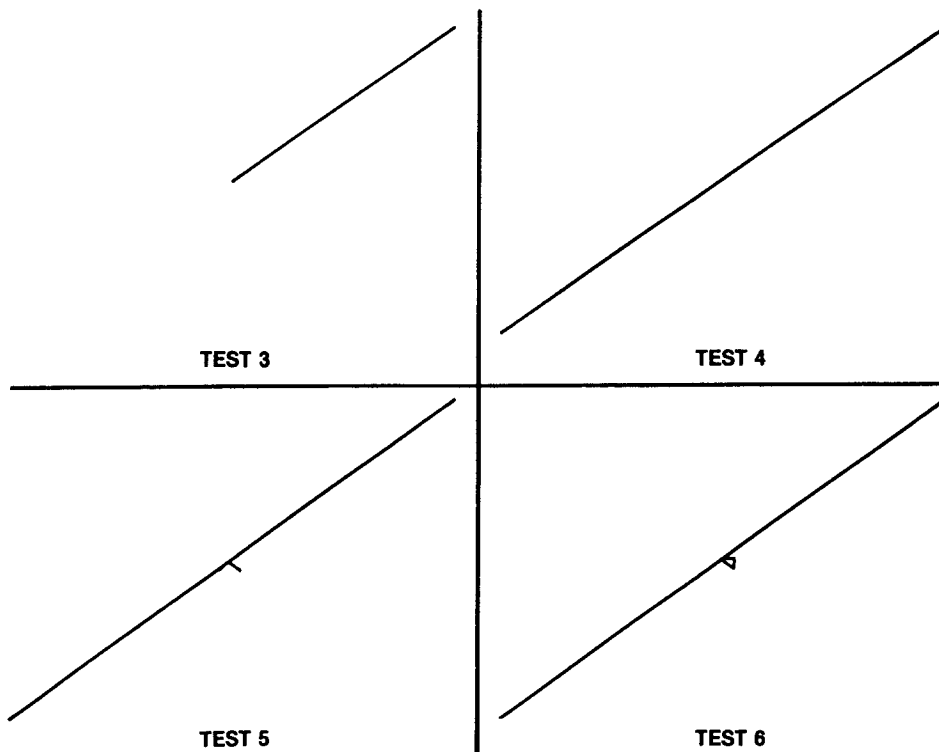

Figure 2-8 Screen 7 : Self-Test Screens During Signature Analysis

Press the coin switch while pressing the 2-player start button. The screen will either be blank or display vectors, depending on settings of the switch toggles at location P10/11 on the game PCB (see *Figure 2-8*).

To exit from this screen, set the self-test switch to *off* or press RESET on the game PCB.

Maintenance, Repair and Parts

This chapter details maintenance and repair information and provides information you need to order parts for your Gravitar™ game. Please note that **common hardware has been deleted** from most of the parts lists. Common hardware includes screws, nuts, washers, bolts, and the like.

The parts lists are arranged in alphanumeric order. For example, all A- prefix numbers come first. Following these are numbers in sequence evaluated up to the hyphen, namely 00- thru 99-, then 000598- thru approximately 190000-.

When ordering parts, please give the part number, part name, applicable figure number of this manual, and serial number of your game. This will help to avoid confusion and mistakes in your order. We hope the results will be less downtime and more profit from your game.

Atari Customer Service numbers are listed in the front of this manual for your convenience.

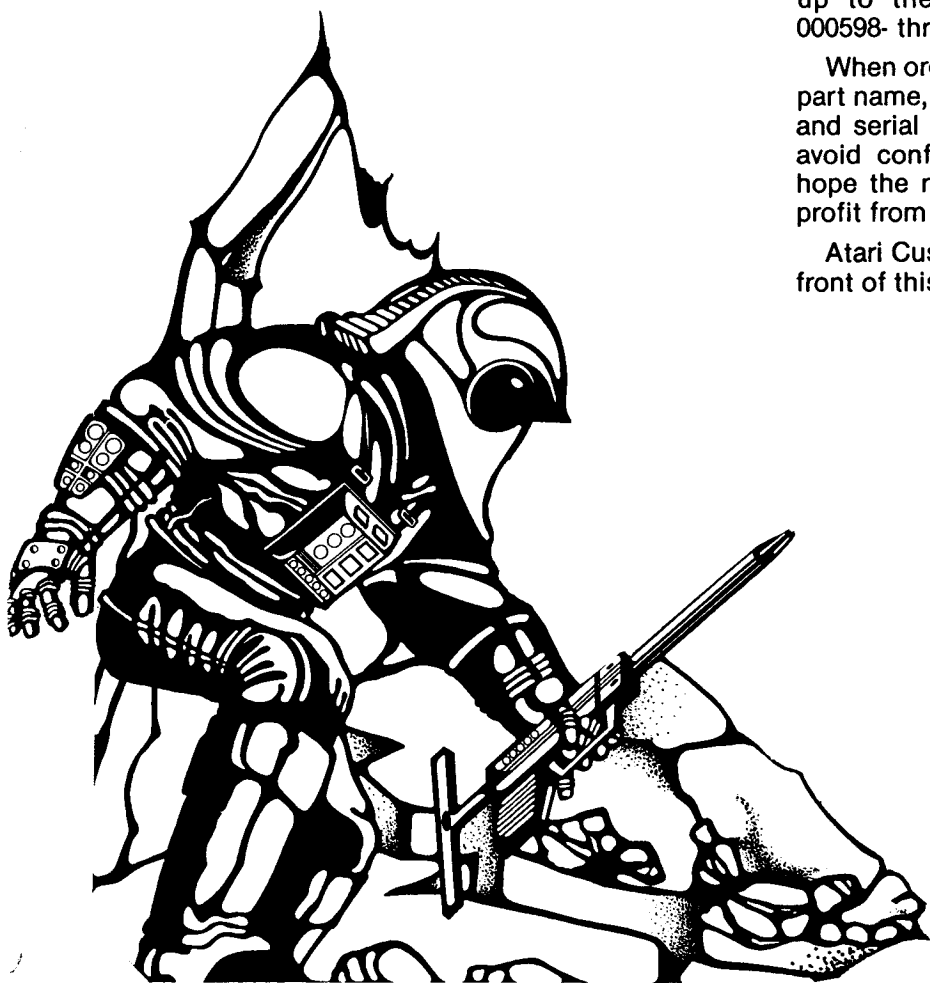

Chapter



A. Cabinet-Mounted Assemblies

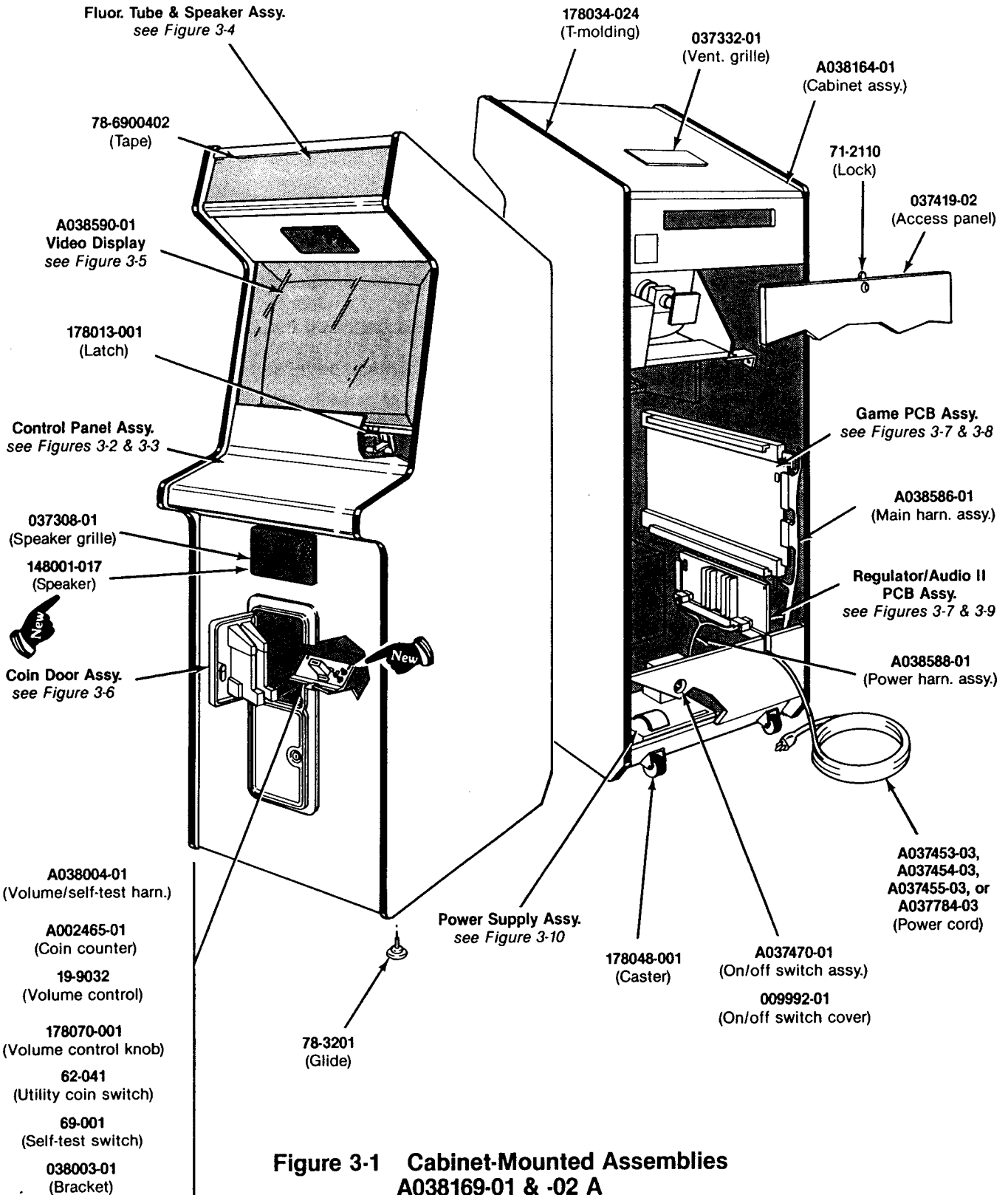

**Figure 3-1 Cabinet-Mounted Assemblies
A038169-01 & -02 A**

Figure 3-1 Cabinet-Mounted Assemblies, continued Parts List

Part No.	Description (Reference Designations and Locations in Bold)
A002465-01	Coin Counter
A037453-03	Strain-Relief Power Cord (U.S. and Canada)
A037455-03	Strain-Relief Power Cord (Australia and New Zealand)
A037470-01	Power On/Off Switch/Mounting Plate Assembly
A037784-03	Strain-Relief Power Cord (United Kingdom, Ireland, Lebanon, Saudi Arabia, India, Hong Kong, Singapore, Egypt, Nigeria, Republic of South Africa, Zimbabwe)
A038004-01	Harness for Volume Control/Self-Test Switch/Coin Counter Assembly
A038164-01	Cabinet Assembly (includes glides and PCB retainers, but not the rear access panel)
A038586-01	Main Harness Assembly
A038588-01	Power Harness Assembly
A038590-01	19-Inch Wells-Gardner Color X-Y Video Display Assembly
<i>The following four items are the technical information supplements to this game:</i>	
SP-206	Gravitar Schematic Package
ST-206-01	Gravitar Label with Self-Test Procedure and Option Switch Settings
TM-183	Service Manual for 19-Inch Wells-Gardner Color X-Y Display
TM-206	Gravitar Operation, Maintenance, and Service Manual
19-9032	Volume Control
62-041	SPDT Momentary-Contact Pushbutton Utility Coin Switch with Black Cap
69-001	DPDT Self-Test Switch
71-2110	Lock Mechanism (for rear access panel)
78-3201	Adjustable Glide
78-6900402	Vinyl Foam Single-Coated Adhesive Tape, ¼-Inch Wide x ⅝-Inch Thick
009992-01	On/Off Switch Cover
037308-01	Speaker Grille
037332-01	Ventilation Grille
037419-02	Rear Access Panel (does not include lock)
038003-01	Bracket for Volume Control, Self-Test Switch, and Coin Counter(s)
038091-01	Molded Coin Box Acceptable substitute is part no. A037491-01
178013-001	Spring Draw Latch
178034-024	¾-Inch Black Plastic T-Molding
178048-001	2-Inch Rigid Caster
178070-001	Volume Control Knob

B. The Control Panel

WARNING
Before removing or repairing any switch on the control panel, unplug the game.

To Open the Control Panel:

1. Open the coin door. Reach up through the opening to the top of the control panel and release the spring-draw latches. (You may also release the spring-draw latches from the back of the game cabinet after opening the rear access panel.)
2. Close the coin door.
3. Lift up on the control panel at the top edge and tilt it toward you. There is foam tape on the display shield, which cushions the shield and prevents liquids from entering the cabinet interior. Make sure this tape is in good condition.

To Repair Leaf Switches:

1. Adjust the leaf switches for a narrow gap. When a switch button is depressed, the resulting wiping action of the cross-bar contacts provides a self-cleaning feature. **Don't burnish the contacts.** To clean them, use electrical contact cleaner.
2. To replace a leaf switch, remove the screw with a Phillips-head screwdriver.

3. To replace the switch button, turn the stamped nut with a wrench in a counterclockwise direction as seen from inside the control panel. The ring on the outside of the control panel should not spin.
4. To reinstall the switch, reconnect the harness wires as shown in the *Schematic Package, Game Wiring Diagram*. Make certain the colored wires are routed to their matching colored tabs on the switch.

To Repair LED Start and SELECT Switches:

These switches have a very low failure rate. If a switch should ever be suspect, first test it using the following directions.

To Test LED Switch:

1. Remove the wires from the suspected switch.
2. Attach the leads of an ohmmeter to normally open and common contacts.
3. Check contacts (push and release the switch button) for closed and open continuity.
4. If the contacts do not operate sharply or always remain closed or open, replace the switch.

To Replace LED Switch:

1. Remove all wires from the faulty switch.
2. Turn the switch counterclockwise while holding the black cone-shaped bushing on the outside of the control panel.
3. Install a new switch using the reverse procedure.
4. Reconnect the harness wires as shown in *Figure 3-2*.

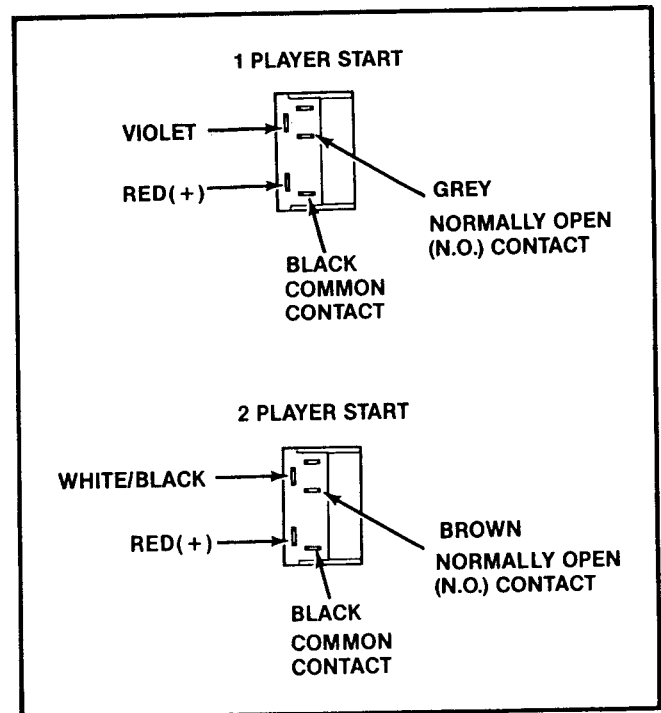
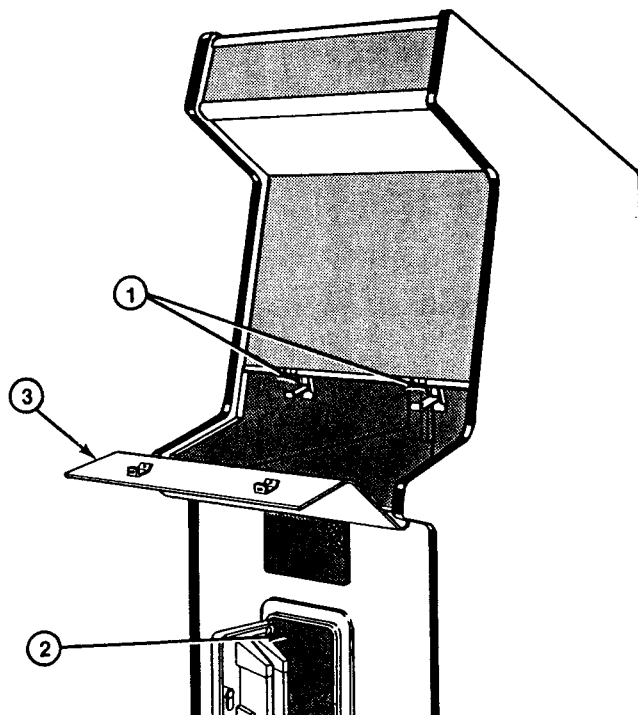
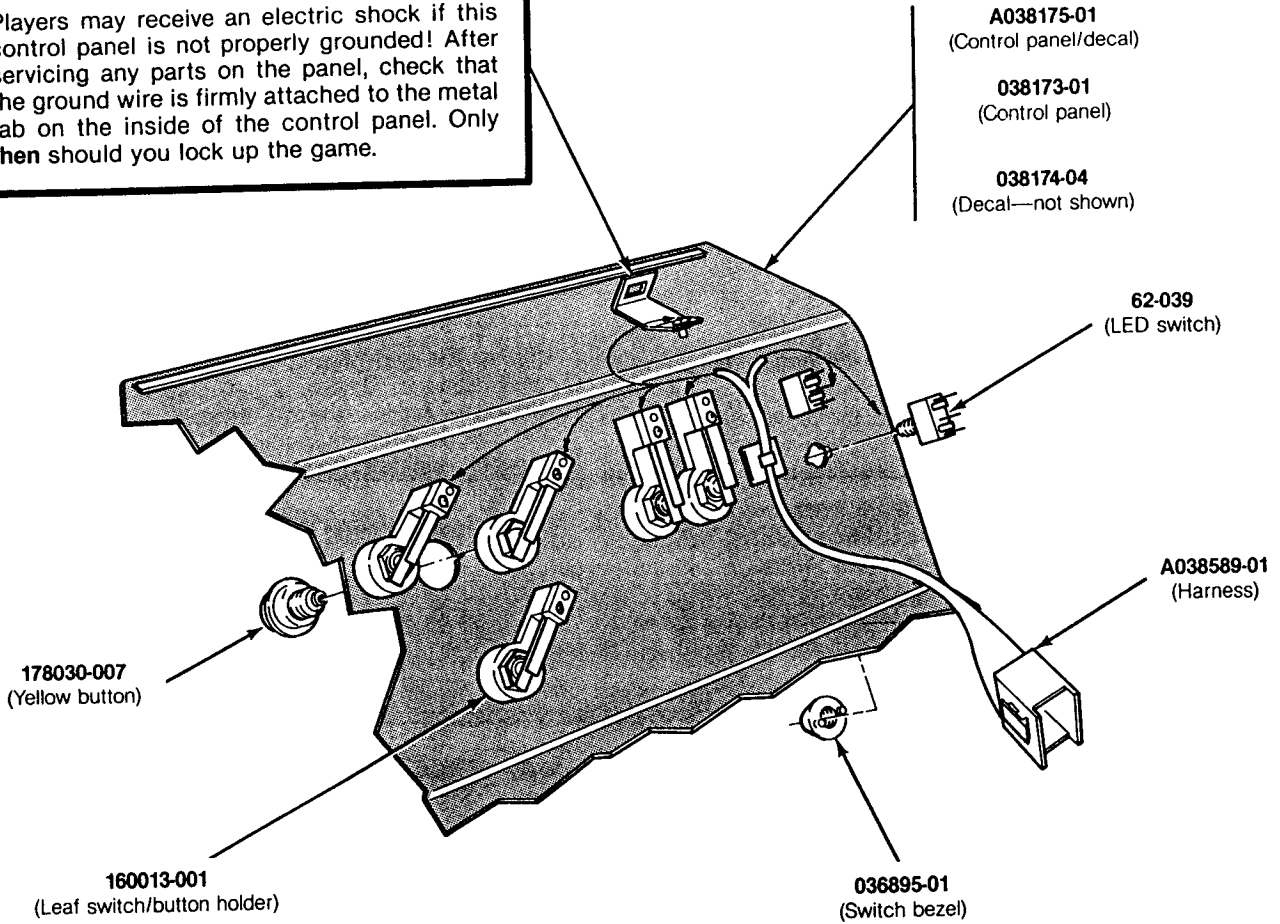

Figure 3-2 Control Panel

WARNING

Players may receive an electric shock if this control panel is not properly grounded! After servicing any parts on the panel, check that the ground wire is firmly attached to the metal tab on the inside of the control panel. Only then should you lock up the game.



**Figure 3-3 Control Panel Assembly
A038176-01 A
Parts List**

Part No.	Description (Reference Designations and Locations in Bold)
A038175-01	Control Panel with Decal
A038589-01	Control Panel Harness Assembly
62-039	SPDT Momentary Pushbutton Start Switch with Red Light-Emitting Diode
036895-01	Black Molded Switch Bezel
038173-01	Control Panel
038174-04	Control Panel Decal
160013-001	Leaf Switch and Button Holder (<i>leaf switch only is part no. 160012-001</i>)
178030-007	Yellow Pushbutton Assembly

C. Fluorescent Tube and Speaker

⚠ WARNING ⚠

Before removing or repairing the fluorescent tube or speaker, **unplug the game.**

If you drop a fluorescent tube and it breaks, it will *implode!* Shattered glass can fly six feet or more from the implosion. Use care when replacing any fluorescent tube.

To Replace Fluorescent Tube:

1. Remove the three sets of hardware that secure the upper attraction panel retainer to the cabinet. *Loosen* the three sets of hardware that secure the lower retainer to the cabinet. Lift the attraction panel up and out of its lower retainer.
2. Remove the cardboard locking tab at each end of the tube. Slightly rotate the tube up or down and carefully remove it from the lampholders.
3. Replace with a new tube. Do not snap the tube in vigorously—you may break it, causing an implosion! Replace the locking tabs.

4. Check that the green ground wire is securely attached to the large metal bracket and the ballast transformer on the wood panel. If the tube is not grounded, it may not start.

To Replace Cabinet Speakers:

5. **Upper speaker.** Remove upper attraction glass. Slide the fluorescent tube and speaker board partially out of the cabinet. Turn it sideways to unplug the 5-pin harness connector. Remove the board from the cabinet.
6. Unplug the two plug-in connectors on the speaker. Note that the white wire (+) connects on the side marked with a painted dot. Remove the hardware that attaches the speaker to the board. Replace the speaker, reinstall the speaker board, and reconnect the harness.
7. **Lower speaker.** Open the rear access panel. Unplug the two plug-in connectors on the speaker. Note that the white wire (+) connects on the side marked with a painted dot. Remove the hardware that attaches the speaker to the cabinet. Install the new speaker, and replace the hardware and connectors.

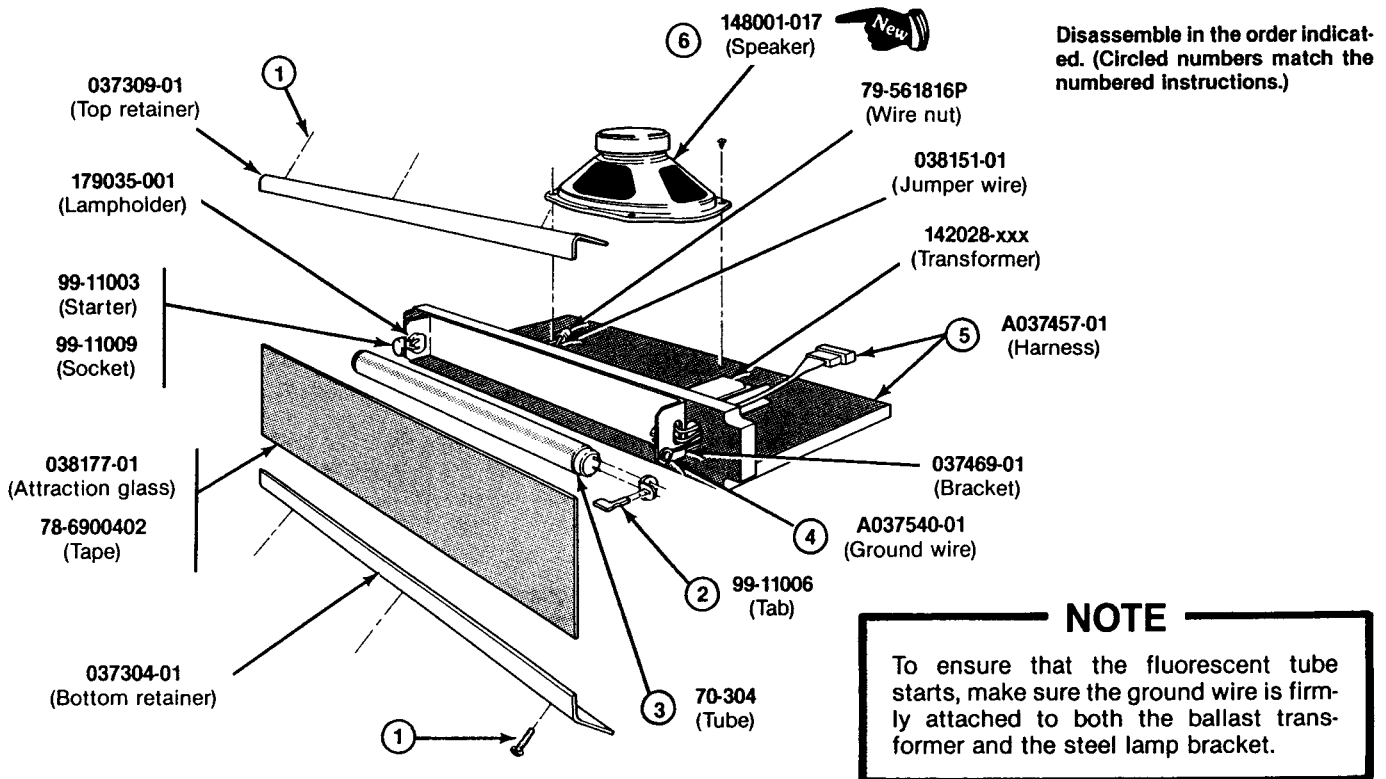

**Figure 3-4 Fluorescent Tube and Speaker
A038161-01 & -02 A**

**Figure 3-4 Fluorescent Tube and Speaker
A038161-01 & -02 A
Parts List**

<i>Part No.</i>	<i>Description (Reference Designations and Locations in Bold)</i>
A037457-01	Tube and Speaker Harness Assembly
A037540-01	Ground Wire with Ring Lug
70-304	18-Inch, 15-W, Cool White Fluorescent Tube
78-6900402	Vinyl Foam Single-Coated Adhesive Tape, ¼-inch Wide x ⅛ inch Thick
79-561816P	Spring-Connector Wire Nut for 16- to 18-Gauge Wires
99-11003	Fluorescent Lamp Starter
99-11006	Fluorescent Lamp Locking Tab <i>(tab consists of two pieces)</i>
99-11009	Starter Socket
037304-01	Bottom Attraction Glass Retainer
037309-01	Top Attraction Glass Retainer
038151-01	15-Inch Jumper Wire
038177-01	Attraction Glass with Graphics
037469-01	Steel Lamp Bracket
142028-001	60 Hz, 118 V, Ballast Transformer <i>(used on A038161-01 assembly)</i>
142028-002	50 Hz, 118 V, Ballast Transformer <i>(used on A038161-02 assembly)</i>
148001-017	6 x 9-Inch, 8 Ω, 6-Ounce Oval Shielded High-Fidelity Speaker
179035-001	2-Pin Fluorescent Lampholder

D. Video Display

To Remove Wells-Gardner Color X-Y Display:

1. Open the rear access panel and unplug the 15-pin display harness connector. Remove the hardware that secures the display chassis to the metal bracket.
2. Open the control panel (see *Figure 3-2*).
3. Lift up on the glass shield. Slide the retainer clip off the wood cleat and remove it through the cutout. Now remove the glass shield by sliding it down and out of the cabinet.
4. Remove the cardboard bezel.
5. Remove the four sets of hardware that secure the display frame to the wood shelf.
6. Carefully pull the display out through the front of the cabinet. Place it on a soft mat in a protected location.

⚠ WARNING ⚠

SHOCK HAZARD

The following procedure should only be performed by a *qualified service technician*. Before removing or repairing the video display, **unplug the game**. As an extra precaution, we highly recommend you **discharge the high voltage** from the picture tube.

High voltages may exist in any video display, even with power disconnected. Use extreme caution and do not touch electrical parts of the display yoke area with your hands or with metal objects in your hands!

IMPLOSION HAZARD

If you drop the display and the picture tube breaks, *it will implode!* Shattered glass and the yoke can fly six feet or more from the implosion. Use care when replacing any display.

**Figure 3-5 Video Display
Parts List**

Part No.	Description (Reference Designations and Locations in Bold)
Wells-Gardner Display A038590-01	
A038593-01	Wells-Gardner Interconnect Assembly
92-053	19-Inch Wells-Gardner Color X-Y Video Display
038181-01	Video Display Support Bracket
037303-01	Display Shield
037322-01	Display Bezel
037330-01	Display Shield Retainer Clip

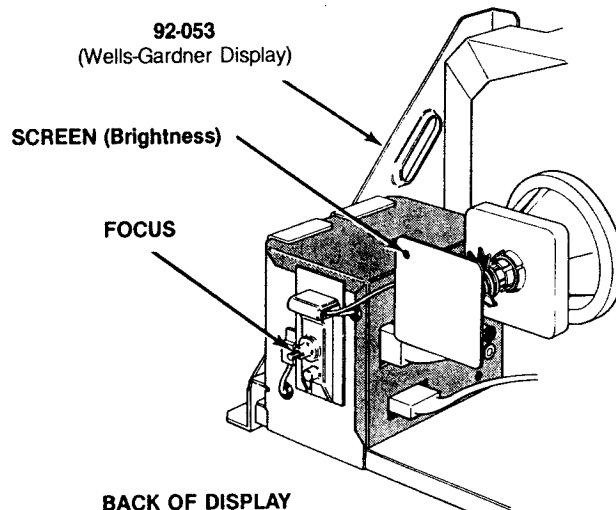

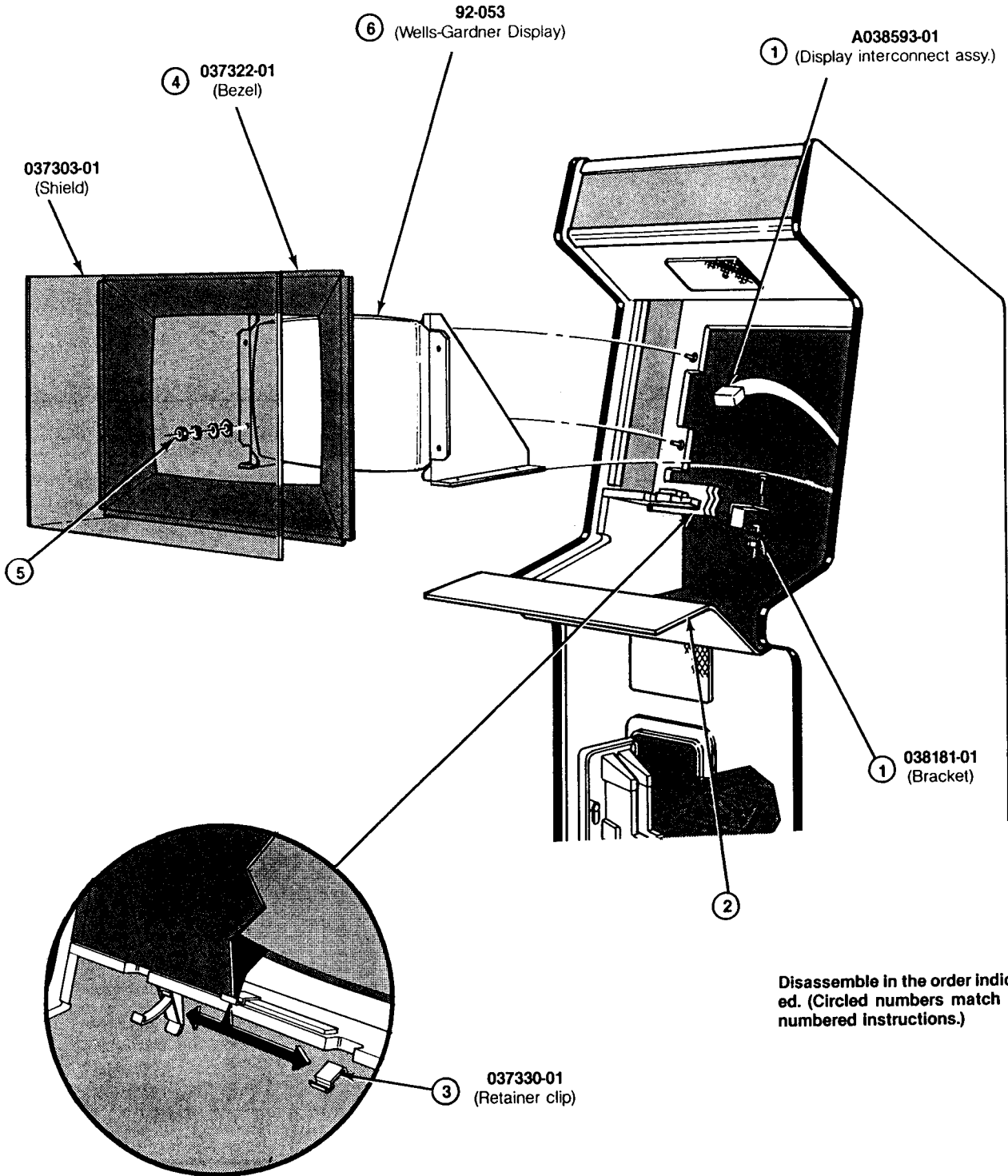

Disassemble in the order indicated. (Circled numbers match the numbered instructions.)

Figure 3-5 Video Display, continued
A038590-01

E. Coin Door

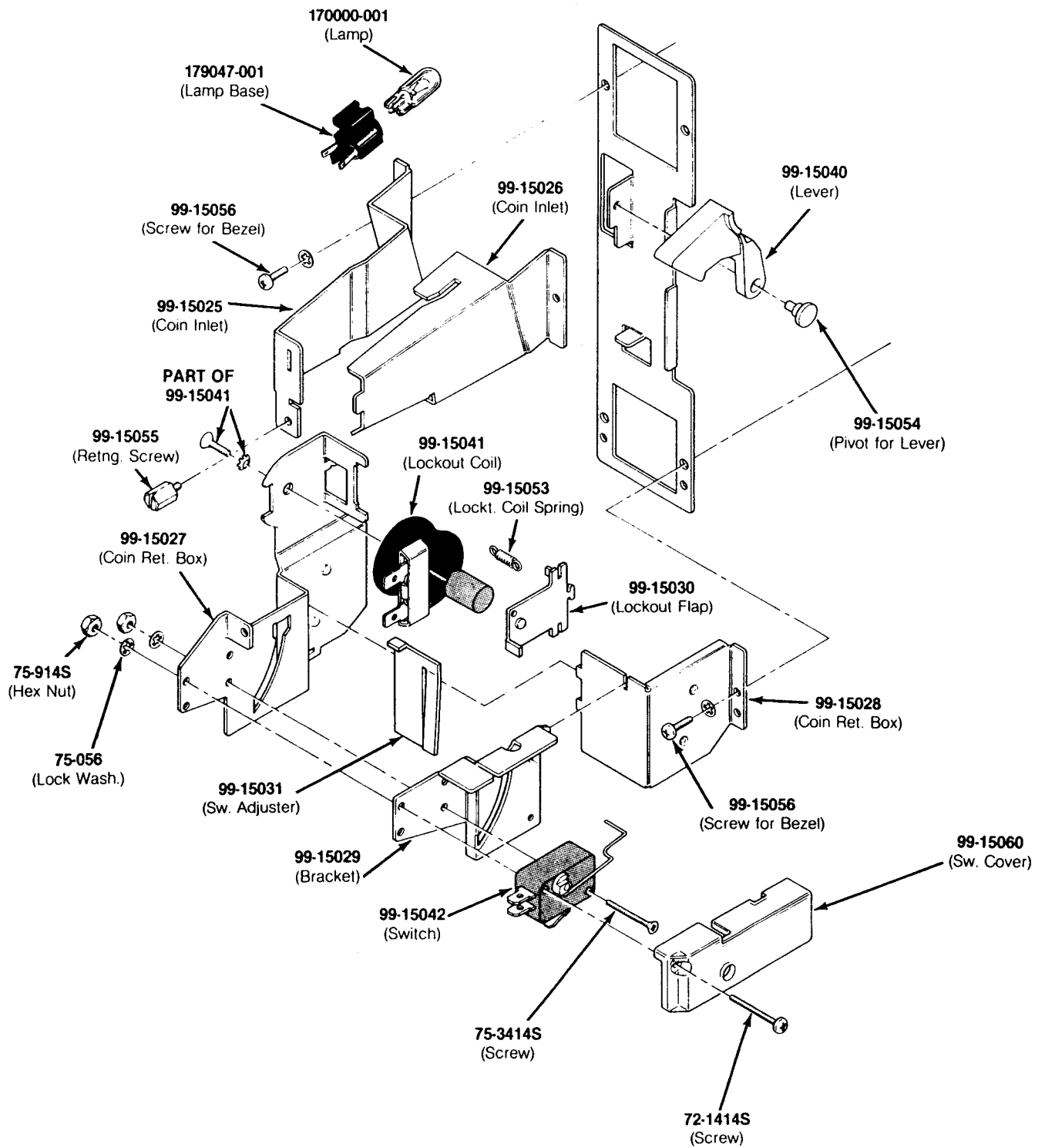

**Figure 3-6 Vertically Mounted Coin Door
A037619-xx D**

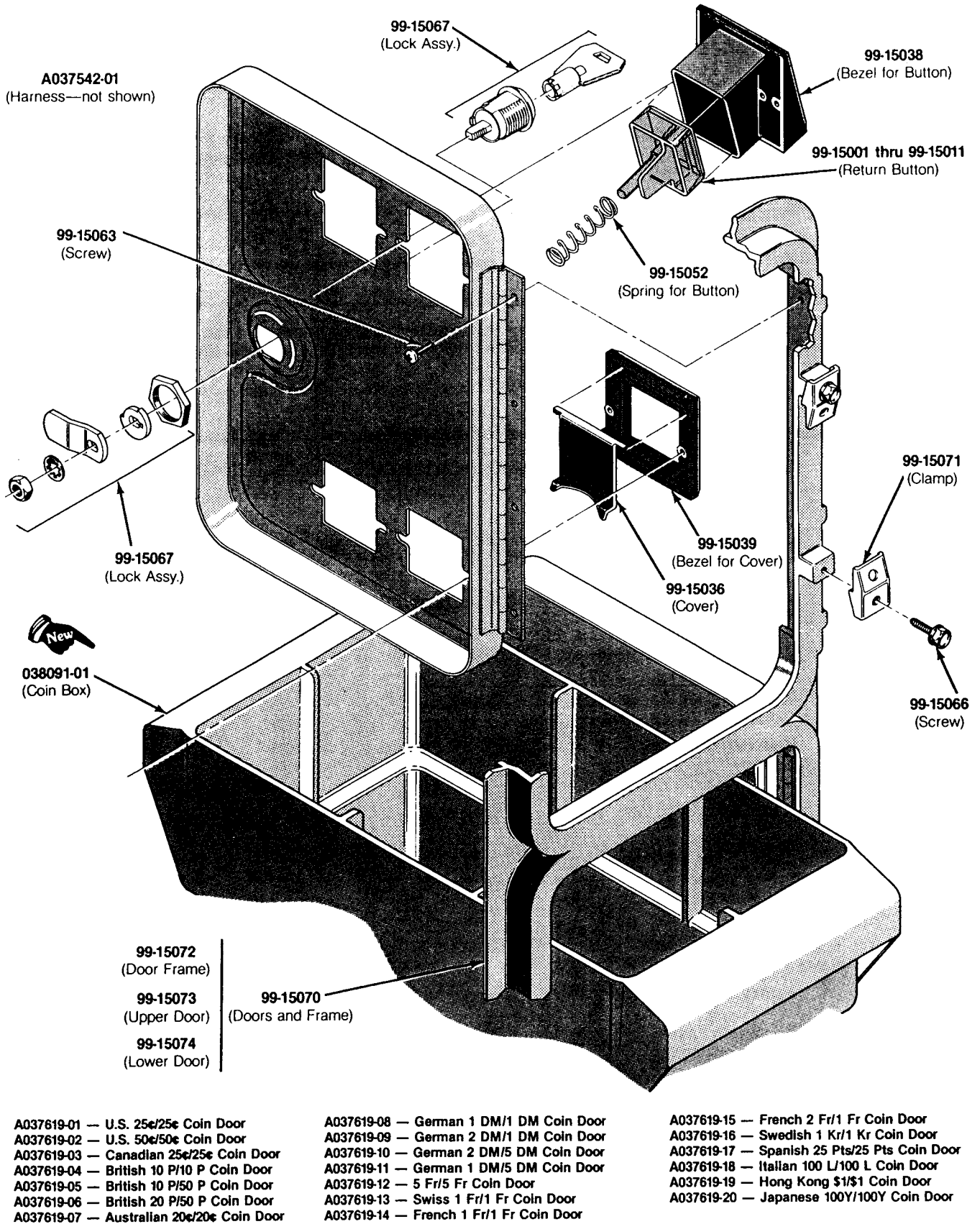

Figure 3-6 Vertically Mounted Coin Door, continued
A037619-xx D

Figure 3-6 Vertically Mounted Coin Door, continued Parts List

Part No.	Description
038091-01	Coin Box <i>(Not included in assembly)</i> Acceptable substitute is part number A037491-01.
A037542-01	Harness Assembly
72-1414S	#4-40 × 1/8-Inch Cross-Recessed Pan-Head Steel Machine Screw
75-056	#6 Internal-Tooth Zinc-Plated Steel Lock Washer
75-914S	#4-40 Steel Machine Hex Nut
75-3414S	#4-40 × 1/8-Inch 82° Cross-Recessed Flat-Head Steel Machine Screw
99-15001	Coin Return Button with U.S. 25¢ Price Plate
99-15002	Coin Return Button with U.S. \$1 Price Plate
99-15003	Coin Return Button with German 1 DM Price Plate
99-15004	Coin Return Button with German 2 DM Price Plate
99-15005	Coin Return Button with German 5 DM Price Plate
99-15006	Coin Return Button with Belgian 5 Fr Price Plate
99-15007	Coin Return Button with French 1 Fr Price Plate
99-15008	Coin Return Button with Japanese 100 Yen Price Plate
99-15009	Coin Return Button with British 10 Pence Price Plate
99-15010	Coin Return Button with Australian 20¢ Price Plate
99-15011	Coin Return Button with Italian 100 Lire Price Plate
99-15023	Base Plate
99-15025	Left Half of Coin Inlet
99-15026	Right Half of Coin Inlet
99-15027	Side Plate of Coin Return Box
99-15028	Base Plate of Coin Return Box
99-15029	Switch Bracket
99-15030	Flap for Lockout Coil <i>(U.S. 25¢)</i>
99-15031	Switch Adjuster
99-15036	Metal Coin Return Cover
99-15038	Bezel for Coin Return Button
99-15039	Metal Bezel for Coin Return Cover
99-15040	Coin Return Lever
99-15042	Coin Switch for U.S. 25¢
99-15052	Spring for Coin Return Button
99-15054	Pivot for Coin Return Lever
99-15055	Retaining Screw
99-15056	#4-40 × 1/8-Inch Cross-Recessed Pan-Head Steel Machine Screw
99-15060	Switch Cover
99-15063	Screw for Hinge
99-15066	Screw for Clamp
99-15067	Lock Assembly
99-15068	Lockout Coil
99-15069	Spring for Lockout Coil
99-15070	Doors and Frame
99-15071	Clamp for Frame
99-15072	Door Frame
99-15073	Upper Door
99-15074	Lower Door
170000-001	6.3V Miniature Wedge-Base Incandescent Lamp
171006-035	Metal Coin Mechanism
179047-001	Lamp Base

F. Printed-Circuit Boards

WARNING

Before removing or repairing any printed-circuit board, unplug the game.

To Remove Printed-Circuit Boards:

1. Open the rear access panel.
2. For the *game PCB*, unplug the two edge connectors. Remove the screw and spacer that secure the PCB to the cabinet. **Carefully** slide the PCB straight out of its slots. Be careful not to twist the board, as this may loosen connections or components. Replace or repair as required.
3. For the *Regulator/Audio II PCB*, disconnect the five small harness connectors on this board.
4. Remove the screw and spacer that secure the Regulator/Audio II PCB to the cabinet, and carefully remove the board from its slot. Do not twist the board, as this may loosen connections or components. Replace or repair as required and reinstall.
5. Make sure that the connectors on the PCB are properly plugged in. Note that they are keyed to fit only one way. If they do not slip on easily, do not force them. **A reversed connector may damage your game and void the warranty.**
6. Replace the hardware that secures the Regulator/Audio II PCB to the cabinet wall. Reinstall the plug-in connectors to the PCB.
7. Close and lock the rear access panel.
8. Ensure that the operation of the game is correct by performing the self-test. Performing self-test is very important when you repair a PCB.

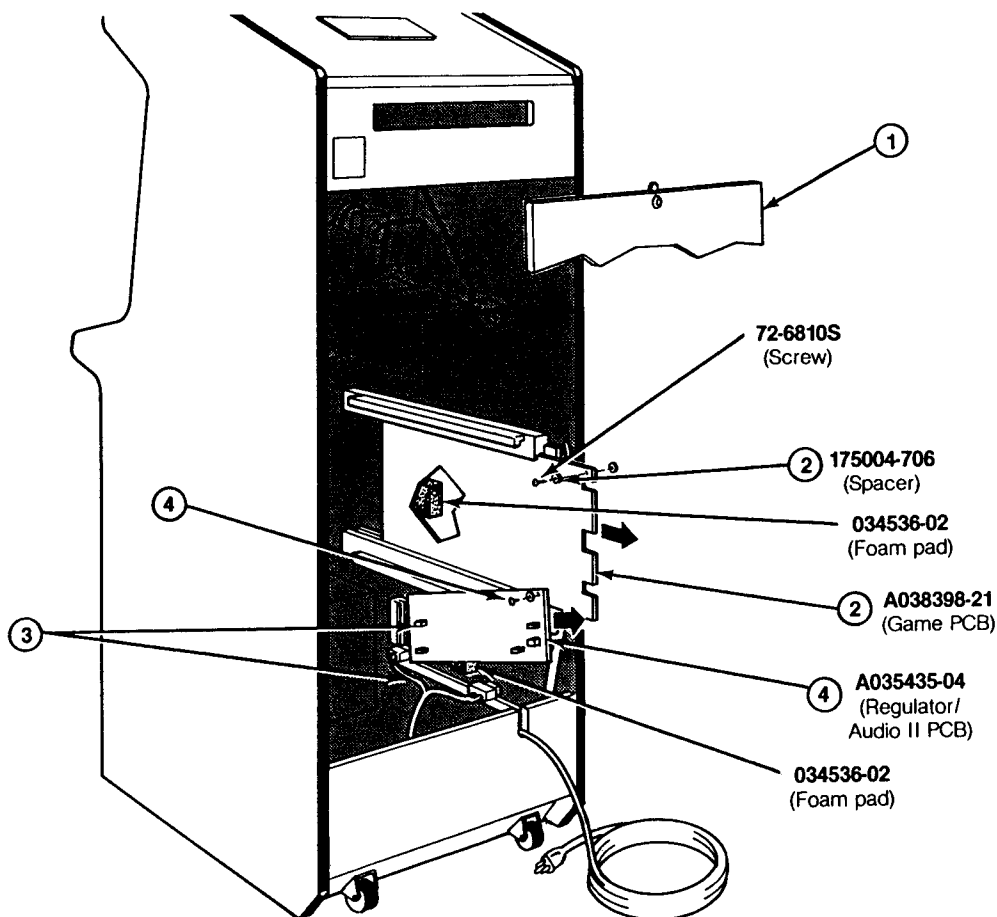

Figure 3-7 Printed-Circuit Board Removal

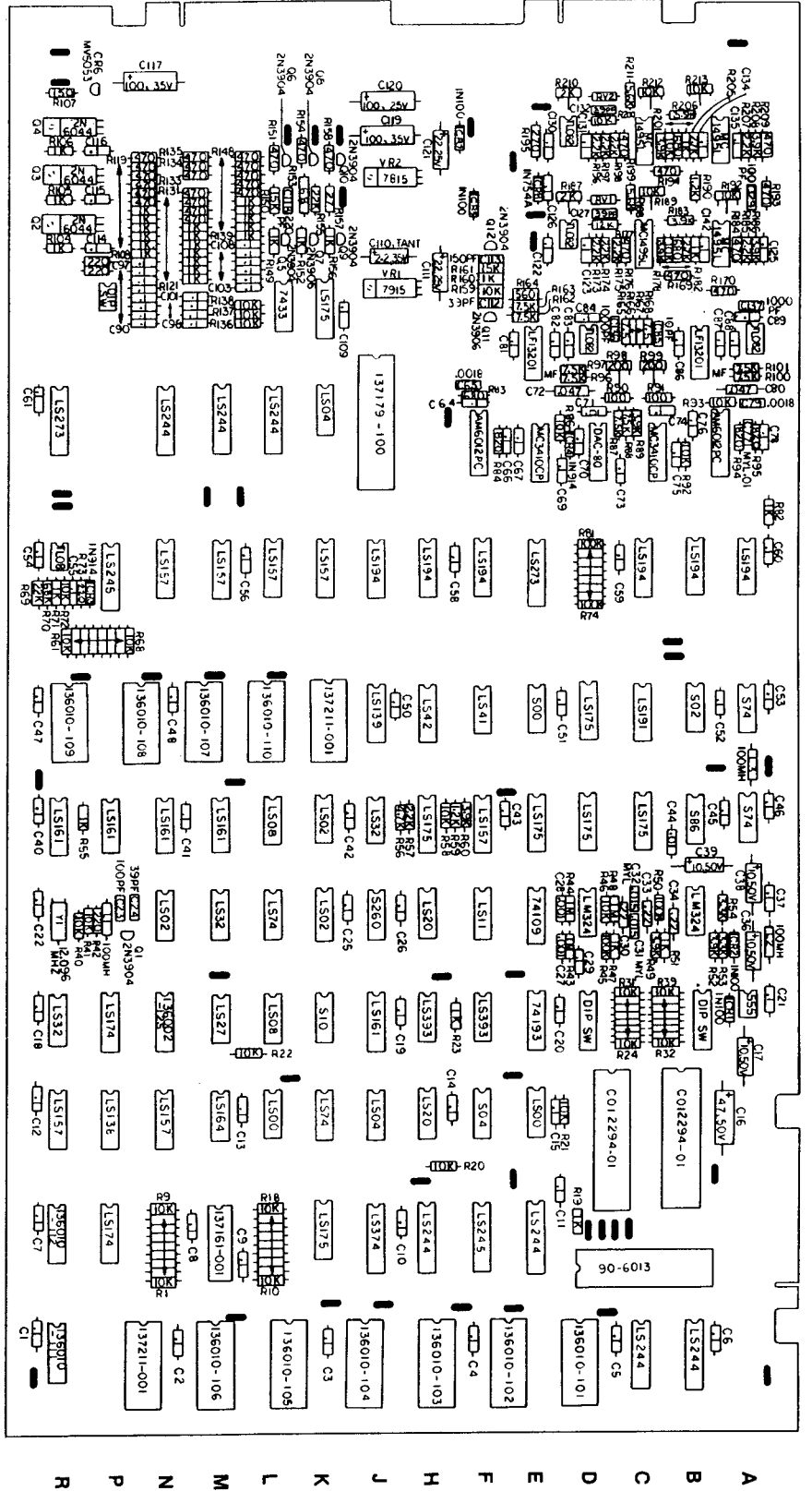

Figure 3-8 Gravitar™ Game PCB Assembly A038398-21 & -22 A

NOTICE TO ALL PERSONS RECEIVING THIS DRAWING
 CONFIDENTIAL—Reproduction forbidden without the specific written permission of Atari, Inc., Sunnyvale, CA. This drawing is only conditionally issued, and neither receipt, nor possession, thereof confers or transfers any right in, or license to use, the subject matter of the drawing or any design or technical information shown thereon, nor any right to reproduce this drawing or any part thereof. Except for manufacture by vendors of Atari, Inc., and for manufacture under the corporation's written license, no right is granted to reproduce this drawing or the subject matter thereof, unless by written agreement with or written permission from the corporation.

Figure 3-8 Gravitar™ Game PCB Assembly, continued Parts List

<i>Part No.</i>	<i>Description (Reference Designations and Locations in Bold)</i>
For A038398-21 Version Only	
27-102182	0.0018 μ F, \pm 10%, 1 kV Radial-Lead Ceramic-Disc Capacitor (C79)
110000-103	10 k Ω , \pm 5%, 1/4 W Resistor (R86, 92, 93)
122002-104	0.1 μ F, 50 V, Ceramic-Disc Radial-Lead Capacitor (C67, 69, 74, 75)
137160-003	10-Bit Digital-to-Analog Converter (C9, E9)
For A038398-22 Version Only	
21-101103	0.01 μ F, \pm 10%, 100 V, Radial-Lead Epoxy-Dipped Capacitor (C77)
27-102182	0.0018 μ F, \pm 10%, 1 kV, Ceramic-Disc Radial-Lead Capacitor (C65)
110000-681	680 Ω , \pm 5%, 1/4 W Resistor (R83)
110000-821	820 Ω , \pm 5%, 1/4 W Resistor (R84, 94, 95)
122002-104	0.1 μ F, 50 V, Ceramic-Disc Radial-Lead Capacitor (C64, 66, 76, 78)
137158-002	12-Bit Digital-to-Analog Converter (A/B9, F9)
For A038398-21 & -22 Versions	
19-315103	10 k Ω Vertical PCB-Mounting Cermet Trimpot (R189, 192, 212, 213) <i>Acceptable substitute is part no. 119002-103.</i>
19-315202	2 k Ω Vertical PCB-Mounting Cermet Trimpot (R187, 210) <i>Acceptable substitute is part no. 119002-202.</i>
19-315501	200 Ω Vertical PCB-Mounting Cermet Trimpot (R98, 99) <i>Acceptable substitute is part no. 119002-501.</i>
21-101153	0.015 μ F, \pm 10%, 100 V Radial-Lead Epoxy-Dipped Mylar Capacitor (C31, 32)
24-250226	22 μ F, 25 V Electrolytic Fixed Axial-Lead Capacitor (C111, 121)
24-350107	100 μ F, 35 V Aluminum Electrolytic Fixed Axial-Lead Capacitor (C117, 119, 120)
24-500106	10 μ F, 50 V Aluminum Electrolytic Fixed Axial-Lead Capacitor (C17, 36, 38, 39)
24-500476	47 μ F, 50 V Aluminum Electrolytic Fixed Axial-Lead Capacitor (C16)
31-1N100	Type-1N100, 100 V Switching Diode (CR1, 2, 5, 7)
31-1N914	Type-1N914, 75 V Switching Diode (CR3, 4)
33-2N3906	Type-2N3906 PCB Switching and Amplifying Transistor (Q7, 11)
34-2N3904	Type-2N3904, 60 V, 1 W NPN Transistor (Q1, 5, 6, 8-10, 12)
34-2N6044	Type-2N6044 Darlington NPN Transistor (Q2-4)
37-555	Type-555 Integrated Circuit (A4)
37-1495	Type-MC1495L Integrated Circuit (A/B11, A/B12, C11, C12)
37-7433	Type-7433 Integrated Circuit (L10)
37-13201	Type-LF13201 Integrated Circuit (B10, E10)
37-74109	Type-74109 Integrated Circuit (E5)
37-74193	Type-74193 Integrated Circuit (E4)
37-LM324	Type-LM324 Integrated Circuit (B5, D5)
37-74LS00	Type-74LS00 Integrated Circuit (E3, L3)
37-74LS02	Type-74LS02 Integrated Circuit (K5, K6, N5)
37-74LS04	Type-74LS04 Integrated Circuit (J3, K9)
37-74LS08	Type-74LS08 Integrated Circuit (L4, L6)
37-74LS14	Type-74LS14 Integrated Circuit (F7)
37-74LS20	Type-74LS20 Integrated Circuit (H3, H5)
37-74LS27	Type-74LS27 Integrated Circuit (M4)
37-74LS32	Type-74LS32 Integrated Circuit (J6, M5, R4)

[Continued on next page]

Figure 3-8 Gravitar™ Game PCB Assembly, continued Parts List

Part No.	Description (Reference Designations and Locations in Bold)
37-74LS42	Type-74LS42 Integrated Circuit (H7)
37-74LS74	Type-74LS74 Integrated Circuit (K3, L5)
37-74LS139	Type-74LS139 Integrated Circuit (J7)
37-74LS157	Type-74LS157 Integrated Circuit (F6, K8, L8, M8, N3, N8, R3)
37-74LS161	Type-74LS161 Integrated Circuit (J4, M6, N6, P6, R6)
37-74LS164	Type-74LS164 Integrated Circuit (M3)
37-74LS174	Type-74LS174 Integrated Circuit (P2, P4)
37-74LS175	Type-74LS175 Integrated Circuit (C6, D6, D7, E6, H6, K2, K10)
37-74LS191	Type-74LS191 Integrated Circuit (C7)
37-74LS194	Type-74LS194 Integrated Circuit (A8, B8, C8, F8, H8, J8)
37-74LS244	Type-74LS244 Integrated Circuit (B1, C1, E2, H2, L9, M9, N9)
37-74LS245	Type-74LS245 Integrated Circuit (F2, P8)
37-74LS273	Type-74LS273 Integrated Circuit (E8, R9)
37-74LS374	Type-74LS374 Integrated Circuit (J2)
37-74LS393	Type-74LS393 Integrated Circuit (F4, H4)
37-74S00	Type-74S00 Integrated Circuit (E7)
37-74S02	Type-74S02 Integrated Circuit (B7)
37-74S04	Type-74S04 Integrated Circuit (F3)
37-74S74	Type-74S74 Integrated Circuit (A6, A7)
37-74S260	Type-74S260 Integrated Circuit (J5)
37-7815	+ 15 V Voltage Regulator (VR2)
37-7915	- 15 V Voltage Regulator (VR1)
37-TL082CP	Type-TL082 Integrated Circuit (A10, D10, D/E11, D/E12, R8)
38-MV5053	Type-MV5053 Light-Emitting Diode (CR6)
41-3003	100 μ H, \pm 10%, Hot-Molded Plastic Fixed R.F. Choke (L1-3) <i>Acceptable substitute is part no. 141002-001.</i>
66-114P1T	4-Station Single-Throw, Dual-Inline-Package Bit Switch (P10)
66-118P1T	8-Station Single-Throw, Dual-Inline-Package Bit Switch (B4, D4)
72-6810S	#8 x $\frac{1}{8}$ -Inch Phillips-Head Screw (<i>secures PCB to cabinet</i>)
79-42C22	22-Contact Medium-Insertion-Force Integrated Circuit Socket (M2)
79-42C24	24-Contact Medium-Insertion-Force Integrated Circuit Socket (D1, E/F1, H1, J1, K7, K/L1, L7, M1, M/N7, N/P1, N/P7, R7)
79-42C40	40-Contact Medium-Insertion-Force Integrated Circuit Socket (B3, C2, C/D3, J9)
81-4302	Nylon Snap-In Fastener
90-6013	Microprocessor (C2)
034536-02	Foam Pad
038178-03	Dual-Slotted PCB Retainer
110000-101	100 Ω , \pm 5%, $\frac{1}{4}$ W Resistor (R90, 91)
110000-102	1 k Ω , \pm 5%, $\frac{1}{4}$ W Resistor (R19, 23, 47, 51, 55, 71, 82, 104-106, 108-113, 121-127, 139-143, 149, 152, 156, 160, 182, 204)
110000-103	10 k Ω , \pm 5%, $\frac{1}{4}$ W Resistor (R1-18, 20-22, 24-41, 46, 58, 61-68, 72, 136-138, 159, 179, 200, 202)
110000-104	100 k Ω , \pm 5%, $\frac{1}{4}$ W Resistor (R45, 50, 74-81)
110000-105	1 M Ω , \pm 5%, $\frac{1}{4}$ W Resistor (R43, 44, 48)
110000-122	1.2 k Ω , \pm 5%, $\frac{1}{4}$ W Resistor (R59, 190)
110000-123	12 k Ω , \pm 5%, $\frac{1}{4}$ W Resistor (R177)
110000-151	150 Ω , \pm 5%, $\frac{1}{4}$ W Resistor (R107)
110000-153	15 k Ω , \pm 5%, $\frac{1}{4}$ W Resistor (R150, 161)

[Continued on next page]

Figure 3-8 Gravitar™ Game PCB Assembly, continued Parts List

Part No.	Description (Reference Designations and Locations in Bold)
110000-221	220 Ω , $\pm 5\%$, 1/4 W Resistor (R42, 73, 102, 103)
110000-222	2.2 k Ω , $\pm 5\%$, 1/4 W Resistor (R57, 173-175, 185, 196-198, 207)
110000-223	22 k Ω , $\pm 5\%$, 1/4 W Resistor (R69, 155)
110000-270	27 Ω , $\pm 5\%$, 1/4 W Resistor (R157)
110000-272	2.7 k Ω , $\pm 5\%$, 1/4 W Resistor (R181, 205)
110000-332	3.3 k Ω , $\pm 5\%$, 1/4 W Resistor (R53, 54)
110000-392	3.9 k Ω , $\pm 5\%$, 1/4 W Resistor (R49, 52, 60, 89, 178, 183, 186, 201, 206, 208)
110000-471	470 Ω , $\pm 5\%$, 1/4 W Resistor (R114-119, 128-131, 133-135, 144-148, 151, 154, 158, 169, 170, 176, 184, 193, 194, 199, 209)
110000-472	4.7 k Ω , $\pm 5\%$, 1/4 W Resistor (R56)
110000-561	560 Ω , $\pm 5\%$, 1/4 W Resistor (R164)
110000-562	5.6 k Ω , $\pm 5\%$, 1/4 W Resistor (R188, 211)
110000-680	68 Ω , $\pm 5\%$, 1/4 W Resistor (R153)
110000-681	680 Ω , $\pm 5\%$, 1/4 W Resistor (R180, 203)
110000-683	68 k Ω , $\pm 5\%$, 1/4 W Resistor (R70)
110001-271	270 Ω , $\pm 5\%$, 1/2 W Resistor (R195)
110003-752	7.5 k Ω , $\pm 1\%$, 1/8 W Resistor (R87, 88, 96, 97, 100, 101, 162, 163, 165-168)
110004-001	Voltage Dependent Resistor (RV1, 2)
121007-473	0.047 μ F, $\pm 10\%$, 50 V, Radial-Lead Epoxy-Dipped Polycarbonate Capacitor (C72, 80)
122000-225	2.2 μ F, $\pm 10\%$, 35 V Tantalum Capacitor (C110)
122002-102	0.001 μ F, 50 V, Ceramic-Disc Radial-Lead Capacitor (C27, 28)
122002-104	0.1 μ F, 50 V, Ceramic-Disc Radial-Lead Capacitor (C1-15, 18-22, 25, 26, 29, 35, 37, 40-43, 45-63, 70, 73, 81-84, 86-101, 103-109, 114-116, 122-126, 130, 131, 134, 135)
122005-103	0.01 μ F, 25 V, Ceramic-Disc Radial-Lead Capacitor (C44, 71)
122008-224	0.22 μ F, 25 V, Ceramic-Disc Radial-Lead Capacitor (C30, 33, 34)
128002-100	10 pF, 100 V, Radial-Lead Epoxy-Dipped Mica Capacitor (C85)
128002-101	100 pF, 100 V, Radial-Lead Epoxy-Dipped Mica Capacitor (C23, 129)
128002-102	1000 pF, 100 V, Radial-Lead Epoxy-Dipped Mica Capacitor (C136, 137)
128002-151	150 pF, 100 V, Radial-Lead Epoxy-Dipped Mica Capacitor (C113)
128002-221	220 pF, 100 V, Radial-Lead Epoxy-Dipped Mica Capacitor (C118)
128002-390	39 pF, 100 V, Radial-Lead Epoxy-Dipped Mica Capacitor (C24, 112, 127, 132)
131002-001	Type-1N754A, 6.8 V Zener Diode (CR8)
136002-125	Programmable Read-Only Memory (N4)
136010-101	Programmable Read-Only Memory (D1)
136010-102	Programmable Read-Only Memory (E/F1)
136010-103	Programmable Read-Only Memory (H1)
136010-104	Programmable Read-Only Memory (J1)
136010-105	Programmable Read-Only Memory (K/L1)
136010-106	Programmable Read-Only Memory (M1)
136010-107	Programmable Read-Only Memory (M/N7)
136010-108	Programmable Read-Only Memory (N/P7)
136010-109	Programmable Read-Only Memory (R7)
136010-110	Programmable Read-Only Memory (L7)
136010-111	Programmable Read-Only Memory (R1)
136010-112	Programmable Read-Only Memory (R2)
137002-001	Type-74S86 Integrated Circuit (B6)

[Continued on next page]

Figure 3-8 Gravitar™ Game PCB Assembly, continued Parts List

<i>Part No.</i>	<i>Description (Reference Designations and Locations in Bold)</i>
137149-001	Type-74LS11 Integrated Circuit (F5)
137159-001	8-Bit Digital-to-Analog Converter (D9)
137161-001	Electrically-Alterable Read-Only Memory (M2)
137177-001	Type-74LS138 Integrated Circuit (P3)
137179-001	Address Controller (J9)
137211-001	Random-Access Memory (N/P1, K7)
137236-001	Type-74S10 Integrated Circuit (K4)
144000-001	12.096 MHz, ± .005% Crystal (Y1)
175004-706	#8 Spacer <i>(secures PCB to cabinet)</i>
179051-002	Test Point <i>Acceptable substitute is part no. 020670-01.</i>
C012294-01	Audio I/O N-Channel MOS/LSI Custom Chip (B3, C/D3)

NOTICE TO ALL PERSONS RECEIVING THIS DRAWING
CONFIDENTIAL: Reproduction forbidden without the specific written permission of Atari, Inc., Sunnyvale, CA. This drawing is only conditionally issued, and neither receipt nor possession thereof confers or transfers any right in, or license to use, the subject matter of the drawing or any design or technical information shown thereon, nor any right to reproduce this drawing or any part thereof. Except for manufacture by vendors of Atari, Inc., and for manufacture under the corporation's written license, no right to reproduce this drawing is granted or the subject matter thereof unless by written agreement with or written permission from the corporation.

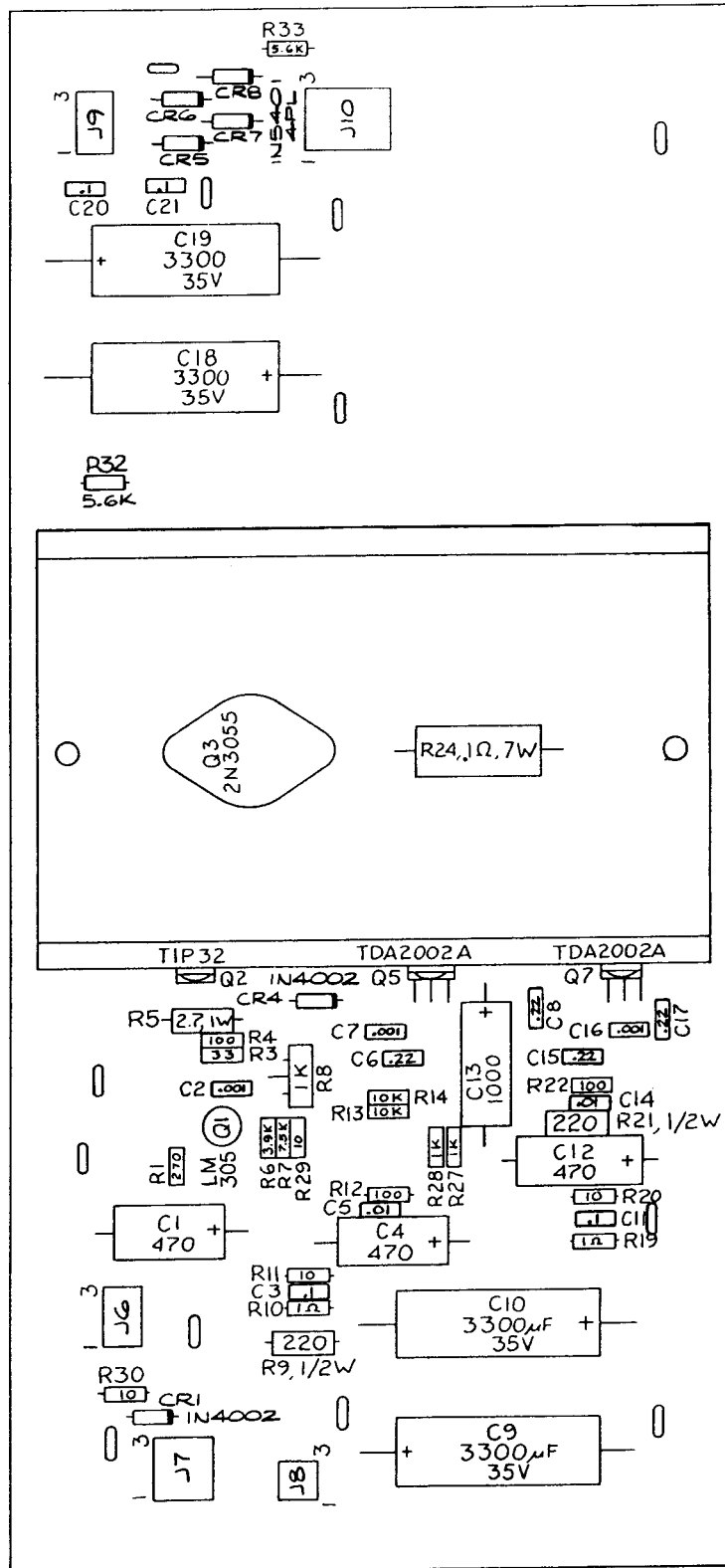

Figure 3-9 Regulator/Audio II PCB Assembly
A035435-04 B

Figure 3-9 Regulator/Audio II PCB Assembly Parts List

Part No.	Description (Reference Designations and Locations in Bold)
19-100P1015	0.1 Ω , $\pm 3\%$, 7 W Wirewound Resistor (R24)
19-315102	1 k Ω Vertical PCB-Mounting Cermet Trimpot (R8) <i>Acceptable substitute is part no. 119002-102</i>
24-250108	1000 μ F, 25 V Aluminum Electrolytic Fixed Axial-Lead Capacitor (C13)
24-250477	470 μ F, 25 V Aluminum Electrolytic Fixed Axial-Lead Capacitor (C1, 4, 12)
24-350338	3300 μ F, 35 V Aluminum Electrolytic Fixed Axial-Lead Capacitor (C9, 10, 18, 19)
29-088	0.1 μ F, 50 V Ceramic-Disc Axial-Lead Capacitor (C3, 11, 20, 21)
31-1N4002	Type-1N4002, 100 V, 1 A Silicon Rectifier Diode (CR1, 4)
31-1N5401	Type-1N5401, 100 V, 3 A Silicon Rectifier Diode (CR5-8)
33-TIP32	Type-TIP32 PNP Power Transistor (Q2)
34-2N3055	Type-2N3055 NPN Silicon Transistor (Q3)
37-LM305	5 V Linear Voltage Regulator (Q1)
72-1608C	#6-32 \times 1/2-Inch Cross-Recessed Pan-Head Corrosion-Resistant Steel Machine Screw (Q3)
72-6606S	#6 \times 3/8-Inch Cross-Recessed Pan-Head Thread-Forming Type-AB Zinc-Plated-Steel Screw (Q5, 7)
72-6810S	#8 \times 3/8-Inch Phillips-Head Screw (<i>attaches PCB to cabinet wall</i>)
75-F60405	#6-32 \times 1/4-Inch Binder-Head Nylon Screw (Q2)
75-99516	#6-32 Nut/Washer Assembly (Q3)
78-16008	Thermally Conductive Compound (Q3)
78-16014	Thermally Conductive Silicon Insulator (Q2)
79-58306	6-Position Connector Receptacle (J6, 9)
79-58308	9-Position Connector Receptacle (J7)
79-58346	12-Position Connector Receptacle (J10)
79-58354	4-Position Connector Receptacle (J8)
034531-01	Heat Sink
034536-02	Foam Vibration Damper
100015-103	0.01 μ F, 25 V Minimum, Ceramic-Disc Axial-Lead Capacitor (C5, C14) <i>Acceptable substitute is part no. 122005-103</i>
110000-010	1 Ω , $\pm 5\%$, 1/4 W Resistor (R10, 19)
110000-100	10 Ω , $\pm 5\%$, 1/4 W Resistor (R11, 20, 29, 30)
110000-101	100 Ω , $\pm 5\%$, 1/4 W Resistor (R4, 12, 22)
110000-102	1 k Ω , $\pm 5\%$, 1/4 W Resistor (R27, 28)
110000-103	10 k Ω , $\pm 5\%$, 1/4 W Resistor (R13, 14)
110000-271	270 Ω , $\pm 5\%$, 1/4 W Resistor (R1)
110000-330	33 Ω , $\pm 5\%$, 1/4 W Resistor (R3)
110000-392	3.9 k Ω , $\pm 5\%$, 1/4 W Resistor (R6)
110000-562	5.6 k Ω , $\pm 5\%$, 1/4 W Resistor (R32, 33)
110000-752	7.5 k Ω , $\pm 5\%$, 1/4 W Resistor (R7)
110001-221	220 Ω , $\pm 5\%$, 1/2 W Resistor (R9, 21)
110009-027	2.7 Ω , $\pm 5\%$, 1 W Resistor (R5)
122002-102	0.001 μ F, 50 V, Ceramic-Disc Axial-Lead Capacitor (C2, 7, 16)
122004-224	0.22 μ F, 25 V Minimum, Ceramic-Disc Axial-Lead Capacitor (C6, 8, 15, 17)
137151-002	Type-TDA2002A 8 W Linear Audio Amplifier Integrated Circuit (Q5, 7)
175004-708	#8 Spacer for Mounting Printed Circuit Board (2 required)
179051-002	Test Point <i>Acceptable substitute is part no. 020670-01</i>

G. Power Supply Assembly

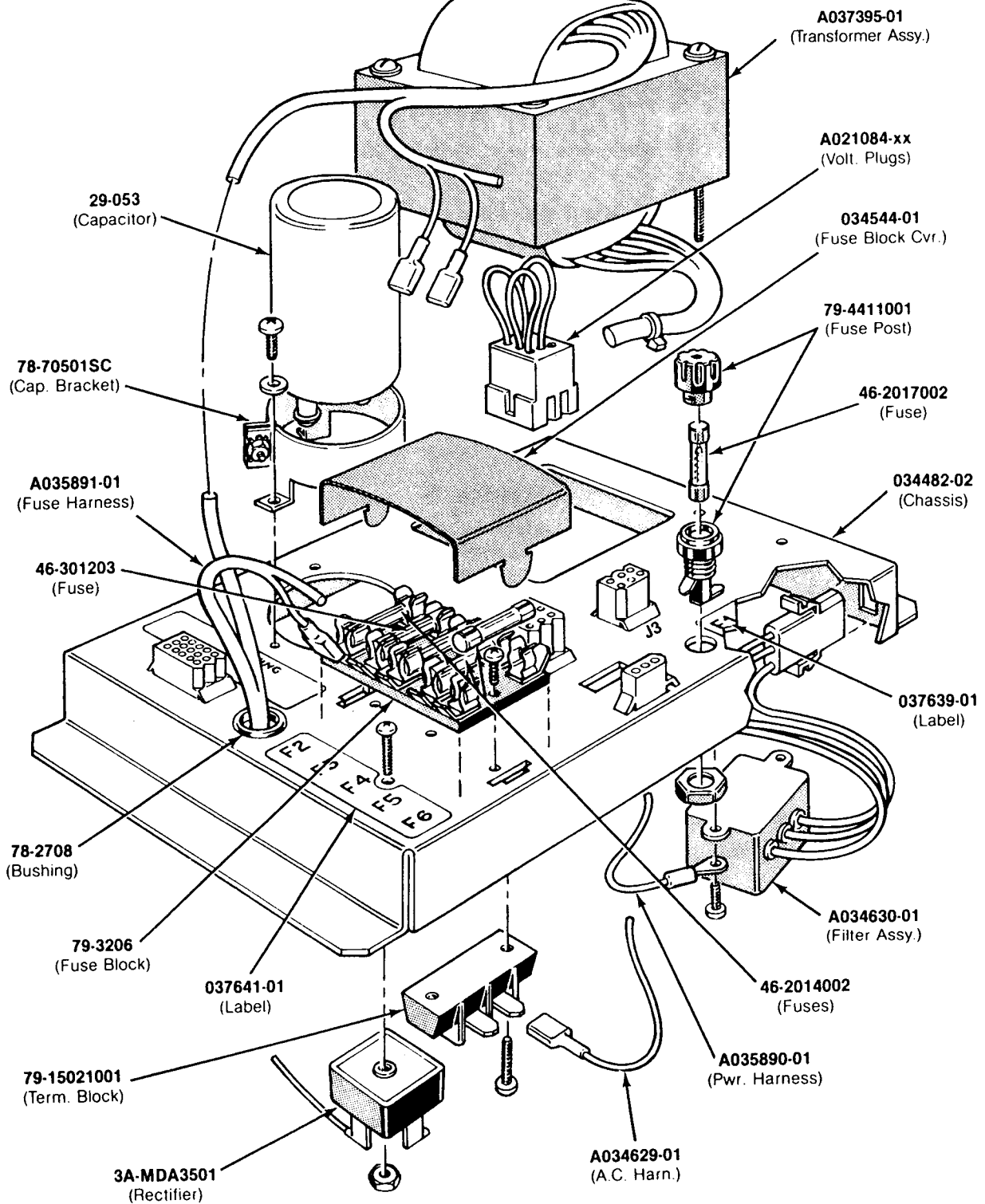

Figure 3-10 Color X-Y Power Supply Assemblies
A037396-xx B

Figure 3-10 Color X-Y Power Supply Assemblies Parts List

Part No.	Description (Reference Designations in Bold)
A021084-01	Voltage Plug for 100 V (violet)
A021084-02	Voltage Plug for 120 V (yellow)
A021084-04	Voltage Plug for 220 V (blue)
A021084-05	Voltage Plug for 240 V (brown)
A034629-01	AC Harness Assembly
A034630-01	RFI Filter Assembly (FL1)
A035890-01	Power Harness Assembly
A035891-02	Fuse Harness Assembly
A037395-01	Color X-Y Transformer Assembly (T1)
29-053	27,000 μ F 15 VDC Electrolytic Capacitor (C1)
3A-MDA3501	Type-MDA 3501 Bridge Rectifier (CR1)
46-2014002	4 A, 250 V, 3AG Slow-Blow Glass Cartridge-Type Fuse (F2, F4-F6)
46-2017002	7 A, 250 V, 3AG Slow-Blow Glass Cartridge-Type Fuse (F1)
46-301203	20 A, 32 V, 3AG Slow-Blow Glass Cartridge-Type Fuse (F3)
78-2708	Nylon Type 6/6 Hole Bushing with $\frac{5}{8}$ -Inch Inside Diameter \times $\frac{5}{16}$ -Inch Outside Diameter \times $\frac{1}{4}$ -Inch Thick
78-70501SC	2-Inch Diameter Capacitor Mounting Bracket
79-15021001	2-Circuit Single-Row Terminal Block
79-3206	5-Position 3AG Fuse Block with $\frac{1}{4}$ -Inch Quick-Disconnect Terminals
79-4411001	Panel-Mounting Non-Indicating 3AG Cartridge-Type Fuse Post
034482-02	Power Supply Chassis Base
034544-01	Fuse Block Cover
037243-01	Metal Base Plate (not shown in illustration)
037639-01	Label for Fuse Value (F1)
037641-01	Label for Fuse Values (F2-F6)

NOTE

A037396-01 power supply assembly has the 120 V plug
A037396-02 has the 100 V, 220 V, and 240 V plugs
A037396-03 has the 220 V and 240 V plugs

Line Voltage Range	Voltage Selection Plug Wire Color
90-110 VAC (100)	Violet
105-135 VAC (120)	Yellow
200-240 VAC (220)	Blue
220-260 VAC (240)	Brown

! WARNING !

Fuse cover must be in place during game operation.

 A Warner Communications Company

ATARI[®]

ATARI, INC.
790 SYCAMORE DRIVE
P.O. BOX 906
MILPITAS, CALIFORNIA 95035
408/942-3100 • TELEX 35-7488

