

MIDWAYS

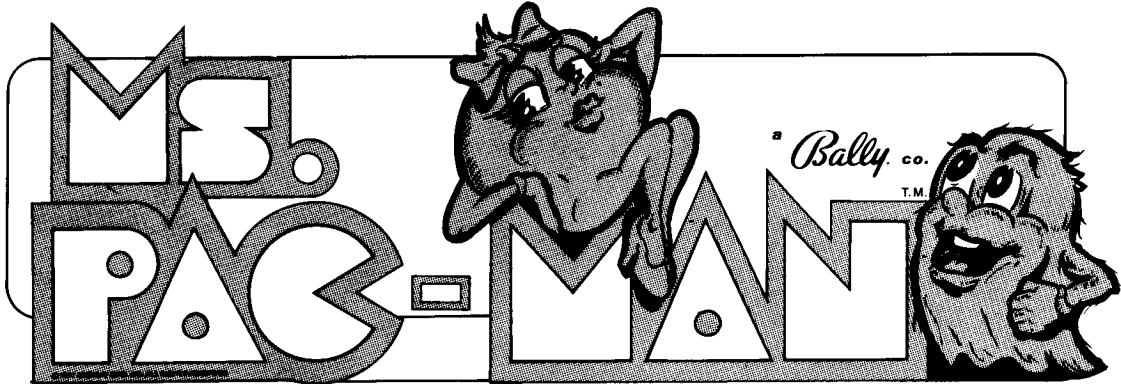

Parts and Operating Manual

UNDER AGREEMENT BY **NAMCO LTD.**



No. 595 UPRIGHT

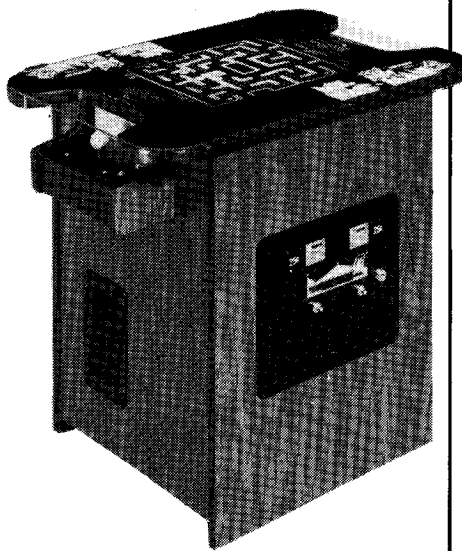

No. 599 COCKTAIL

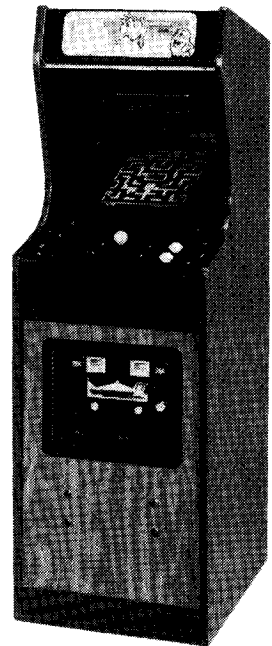

No. 602 MINI



MIDWAY MFG. CO.

A BALLY COMPANY

10750 W. GRAND AVENUE
FRANKLIN PARK, ILLINOIS 60131
USA

Phone: (312) 451-1360 Cable Address: MIDCO Telex No.: 72-1596

TABLE OF CONTENTS

DESCRIPTION	PAGE
I. Introduction	1-1
II. Location and Setup	
Inspection	2-1
Installation	2-1
Self-Test	2-4
Game Volume Adjustment Control	2-4
Option Switch Settings	2-5
Game Operation	2-6
Self-Test Mode	2-6
Attract Mode	2-8
Ready-to-Play Mode	2-10
Play Mode	2-10
Two Player Operation	2-11
III. Maintenance and Repair	
Cleaning	3-1
Fuse Replacement	3-1
Opening the Control Panel	3-2
Removal of Main Display Glass and T.V. Bezel	3-4
T.V. Monitor Replacement	3-5
Printed Circuit Board Replacement	3-8
Opening the Attraction Panel	3-9
Coin Door Maintenance	3-11
IV. Illustrated Parts Breakdown	
No. 595 — Ms. Pac-Man — Upright — Header Fluorescent Light Assy.	4-1
No. 595 — Ms. Pac-Man — Upright — Header Fluorescent Light Assy. — Parts List	4-1
No. 595 — Ms. Pac-Man — Upright — Front	4-2
No. 595 — Ms. Pac-Man — Upright — Front — Parts List	4-3
No. 595 — Ms. Pac-Man — Upright — Rear Access	4-4
No. 595 — Ms. Pac-Man — Upright — Rear Access — Parts List	4-5
No. 602 — Ms. Pac-Man — Mini — Front	4-6
No. 602 — Ms. Pac-Man — Mini — Front — Parts List	4-7
No. 602 — Ms. Pac-Man — Rear Access	4-8
No. 602 — Ms. Pac-Man — Rear Access — Parts List	4-9
No. 599 — Ms. Pac-Man — Cocktail — Front	4-10
No. 599 — Ms. Pac-Man — Cocktail — Front — Parts List	4-11
No. 599 — Ms. Pac-Man — Cocktail — Interior Access	4-12
No. 599 — Ms. Pac-Man — Cocktail — Interior Access — Parts List	4-13
Ms. Pac-Man — Transformer Board Assy.	4-15
Ms. Pac-Man — Transformer Board Assy. — Parts List	4-15
Front Door Assy. — U.S.A. 25¢	4-16
Front Door Assy. — U.S.A. 25¢ — Parts List	4-17
Ms. Pac-Man — Control Assy. — All Versions	4-18
Ms. Pac-Man — Control Assy. — All Versions — Parts List	4-19

TABLE OF CONTENTS (cont'd)

V. Technical Troubleshooting	5-1
Introduction	5-1
General Suggestions	5-1
Harness Component Troubleshooting	5-1
Transformer and Line Voltage Problems	5-2
A Glossary of Microprocessor Terms	5-3
Introduction to the Z-80 CPU	5-3
General Purpose Registers	5-4
Arithmetic and Logic Unit (ALU)	5-4
Instruction Register and CPU Control	5-4
Z-80 CPU Pin Description	5-4
VI. T.V. Monitor Manual	6-1
Introduction	6-1
Symptom Diagnosis	6-2
Guide to Schematic Symbols	6-3
Troubleshooting	6-5
Theory of Operation	6-6
Differences Between Monitors	6-8
Parts Interchangeability	6-9
Monitor Schematic — Wells-Gardner 19"	6-10
Replacement Parts List — Wells-Gardner 19"	6-11
Monitor Schematic — Electrohome 19"	6-13
Replacement Parts List — Electrohome 19"	6-14
Monitor Schematic — Electrohome 13"	6-18
Replacement Parts List — Electrohome 13"	6-19
VII. Schematics and Wiring Diagrams	
Wiring Diagram w/ Credit Multiplier — Upright	7-1
Wiring Diagram w/ Credit Multiplier Bypass — Upright	7-2
Wiring Diagram w/ Credit Multiplier — Mini	7-3
Wiring Diagram w/ Credit Multiplier Bypass — Mini	7-4
Wiring Diagram w/ Credit Multiplier — Cocktail	7-5
Wiring Diagram w/ Credit Multiplier Bypass — Cocktail	7-6
Game Logic Board — Component Layout	7-8
Game Logic Board — Schematic	7-9
V-RAM Addresser Board — Component Layout	7-10
V-RAM Addresser Board — Schematic	7-11
Z-80 Sync Buss Controller — Component Layout	7-12
Z-80 Sync Buss Controller — Schematic	7-13
Auxiliary Board — Component Layout	7-14
Auxiliary Board — Schematic	7-15
Filter Board — Component Layout	7-16
Filter Board — Schematic	7-17
Credit Multiplier Board — Component Layout	7-18
Credit Multiplier Board — Schematic	7-19

TABLE OF FIGURES

FIGURE		PAGE
1	Assigned point values	1-2
2	Location of serial number, on/off switch, interlock switch & major sub-assemblies.....	2-2
3	Major sub-assemblies (cont. from FIG 2)	2-3
4	Interlock switch operation	2-3
5	Location of volume control & option switch	2-4
6	Option switch settings	2-5
7	Identification of "on screen" graphics during play	2-6
8	Location of fuses	3-1
9	Removing control panel — Upright & Mini games.....	3-2
10	Opening Cocktail game	3-3
11	Removing control panel — Cocktail game	3-3
12	Removing display glass — Upright game	3-4
13	Removing display glass — Mini game	3-4
14	Removing top glass — Cocktail game	3-5
15	Removing monitor — Upright game	3-6
16	Removing monitor — Mini game	3-6
17	Opening Cocktail game	3-7
18	Removing monitor — Cocktail game	3-7
19	Removing printed circuit boards	3-8
20	Removing attraction panel — Upright game	3-9
21	Replacing fluorescent starter — Upright game	3-10
22	Replacing fluorescent light mounting bracket & speaker — Upright game	3-10
23	Removing attraction panel — Mini game	3-10
24	Replacing speaker — Mini game	3-11
25	Removing and replacing coin acceptor	3-11
26	Cleaning the metal coin acceptor	3-12
27	Lubricating the metal coin acceptor.....	3-12
28	Opening the plastic coin acceptor	3-13
29	Changing the plastic coin acceptor to accept American or Canadian quarters	3-13
30	Changing difficulty level of game	3-14

Ms. Pac-Man

IMPORTANT NOTE

DO NOT plug in your new game yet. Before you do anything to your game, we recommend that you read SECTIONS I and II of this manual completely. It will not take more than a few minutes and it may be very helpful.

I. Introduction

MS. PAC-MAN is a one or a two player game. There are three models: the "UPRIGHT", "MINI", and "COCKTAIL TABLE". When the two player mode is selected on the Upright or Mini model, the players take turns at the controls to guide their player through the game course. If you have purchased the Cocktail Table model of this game, the rules of play are the same. The only **difference** is that in the two player mode of the Cocktail Table game, the picture flips to face you when it's your turn.

When playing this game, you are in complete control of MS. PAC-MAN. She will go wherever you tell her to. And she just loves to eat dots. However, she doesn't like the four ghosts, BLINKY (red), PINKY (pink), INKY (turquoise), and SUE (amber) because they feel the same way about her as she does about dots.

BLINKY, PINKY, INKY, and SUE are four **VERY SMART** ghosts. They move very fast and seem to have a sixth sense which always lets them know exactly where MS. PAC-MAN is in the maze. They never give up in their pursuit of her. One of their favorite tricks is to divide and try to trap her between them. You really have to keep an eye on them.

But MS. PAC-MAN can turn the tables on these four ghosts for short periods of time during each maze. All she has to do is let them get fairly close in their pursuit of her and then eat one of the four flashing ENERGIZER DOTS that every maze begins with (one close to each corner of the maze). When this happens, it causes the four ghosts to turn blue with

fright no matter where they are in the maze. This is because they know that when she eats an ENERGIZER DOT it gives MS. PAC-MAN the ability to eliminate them. However, she can **ONLY** eliminate them for as long as they are blue.

The ghosts will only stay blue for a few seconds after MS. PAC-MAN eats an ENERGIZER DOT. But they do give a warning **BEFORE** they turn back to their original colors — they start to flash.

As your skill level increases, the four ghosts speed up their pursuit of MS. PAC-MAN and they stay blue for **shorter and shorter** periods of time after she eats an ENERGIZER DOT until, in the high number mazes, they do not turn blue at all.

One bonus player (this is switch selectable) can be awarded to you as you reach or pass a certain preselected point value. The assigned point values for all items that can be eaten are as listed in Figure 1.

Major New Features

A major new feature of your MS. PAC-MAN game is that there are four different mazes with varying numbers of exits and varying exit locations. The mazes are generally more difficult than that of PAC-MAN.

Another major new feature is that the maze identifier symbols move throughout the maze and are thus more difficult to get.

Game Objective

The object of the game is to **HAVE FUN** and survive as long as possible while constantly improving your skills and eating as many dots and eliminating as many ghosts as you can. As you do this, each following maze will be harder and harder to complete.

OBJECT EATEN	POINT VALUE
DOTS	10 POINTS EACH
ENERGIZER DOTS	50 POINTS EACH
1ST GHOST	200 POINTS
2ND GHOST	400 POINTS
3RD GHOST	800 POINTS
4TH GHOST	1600 POINTS
CHERRIES	100 POINTS
STRAWBERRY	200 POINTS
ORANGE	500 POINTS
PRETZEL	700 POINTS
APPLE	1000 POINTS
PEAR	2000 POINTS
BANANA	5000 POINTS

Figure 1 Assigned point values

NOTE: After you complete the BANANA maze, the maze identifier symbols will appear and move through the maze in **RANDOM ORDER** and will retain their **ORIGINAL** point values.

II. Location and Setup

INSPECTION

1. Remove the game from its shipping crate.
2. Inspect the entire outside of it for any signs of damage.
 - Any scratches? Dents? Cracks?
 - Any broken controls?
 - Any broken glass or plastic?
 - Just look it over closely and make a note of any signs of damage.
3. Remove the shipping cleats from the bottom of the cabinet.
4. Install the four levelers, one at each corner of the cabinet.
 - Level the cabinet.
5. Open the cabinet and inspect the inside of the game for any signs of damage. See Figure 2.
 - Also check to make sure all plug-in connectors on the wire harness are firmly seated.

NOTE: ALL connectors or plugs are keyed so they will only go together when all pins are properly lined up.

- Replug any connectors found unplugged. **DO NOT FORCE PLUGS ONTO CONNECTORS. DO NOT FORCE PLUGS TOGETHER.** If it won't go on easily, assuming the keys are lined up, it either does not belong there or is damaged.
 - Make sure all printed circuit boards (P.C.B.'s) are firmly seated in their connectors. See Figure 2. These connectors are also keyed. The P.C.B.'s will only go into them one way without being damaged.
 - Note the location of the game's serial number. See Figure 2.
 - Check all major subassemblies to be sure they are mounted securely. These are called out in Figures 2 & 3.
 - Power supply.
 - Control panel(s).
 - T.V. monitor.
 - Other P.C.B.'s and/or P.C.B. rack, etc.
 - Transformer board assembly.
6. Make a note of any problems that can't be easily corrected.
 7. Call your distributor and/or service man about your problem list.

INSTALLATION

1. Location requirements:

Power:

Domestic 110 V @ 60 Hz

Foreign 200 V to 240 V @ 50 Hz

Temperature: 32° to 100° F (0° to 38° C)

Humidity: Not over 95% relative

Space required:

Upright 25" x 33" (63 x 84cm)

Mini 20" x 24" (50 x 60cm)

Cocktail 32" x 22" (81 x 55cm)

Game height:

Upright 70" (175cm)

Mini 61" (153cm)

Cocktail 29" (73cm)

2. Voltage Selection:

Your game is designed to work properly on the line voltage where you are located. Check your line voltage with a meter to determine what its value is. Then check the power input wires to the main power supply transformer on your game to be sure they are connected to taps which correspond to your line voltage value.

If the power input wires to the main power supply transformer are not connected to taps which correspond to your local line voltage, move them to the proper taps.

If the line voltage in your area falls outside the upper or lower limits of the range of inputs covered by the main power supply transformer, **DO NOT PLUG YOUR GAME IN** until you have talked with your distributor and/or service man and obtained a solution to this problem. Otherwise you could damage your game.

3. Interlock and power ON/OFF switches. See Figure 2.

- To help prevent the possibility of getting an electric shock while working inside the game cabinet, interlock switches have been installed at each cabinet access door (this **DOES NOT** include the coin door in the Upright and Mini models).
- When any access door is opened, the interlock switch installed there turns off all power to the game.
- Check each interlock switch for proper operation.

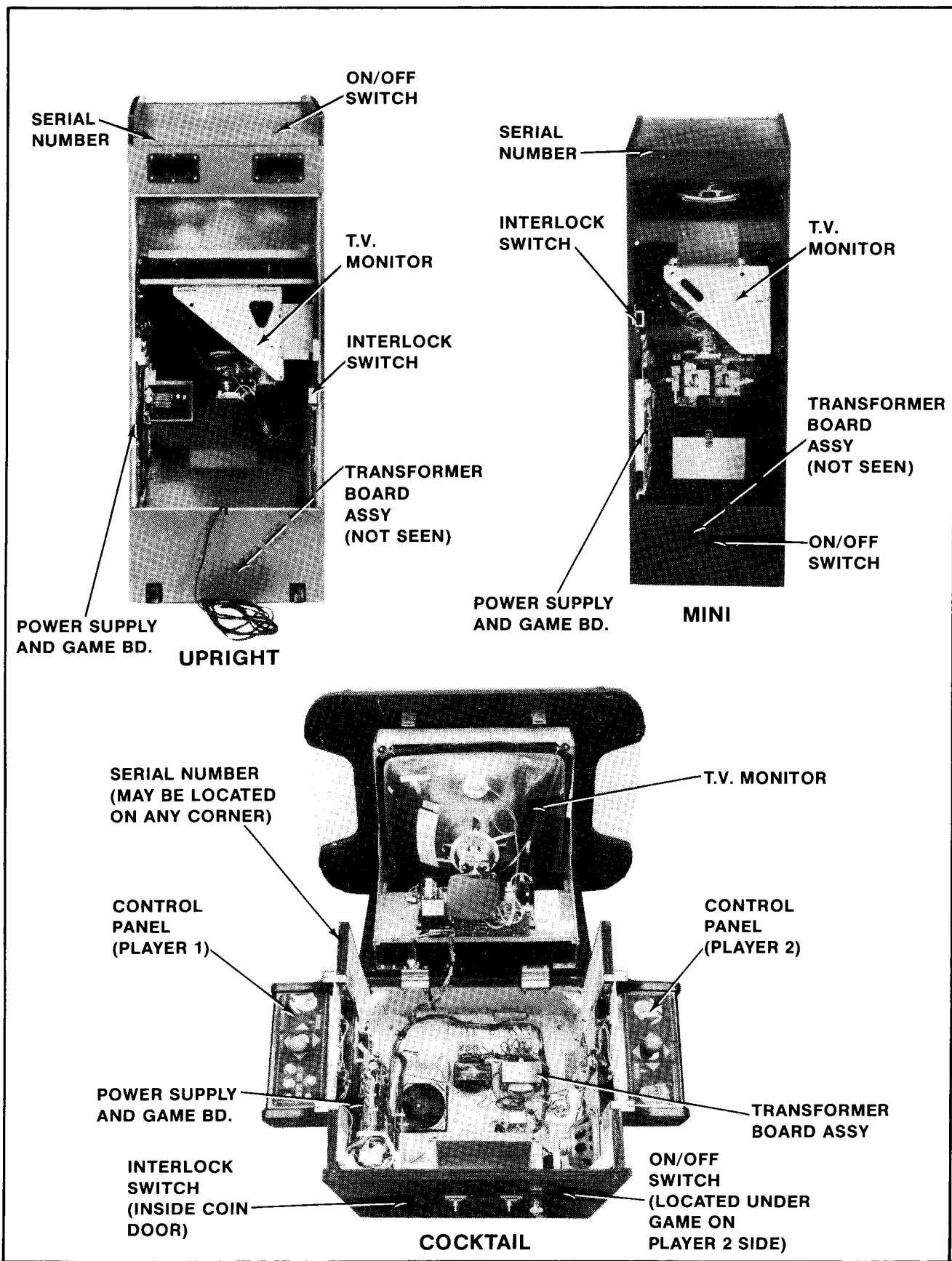

Figure 2 Location of serial number, on/off switch, interlock switch & major sub-assemblies

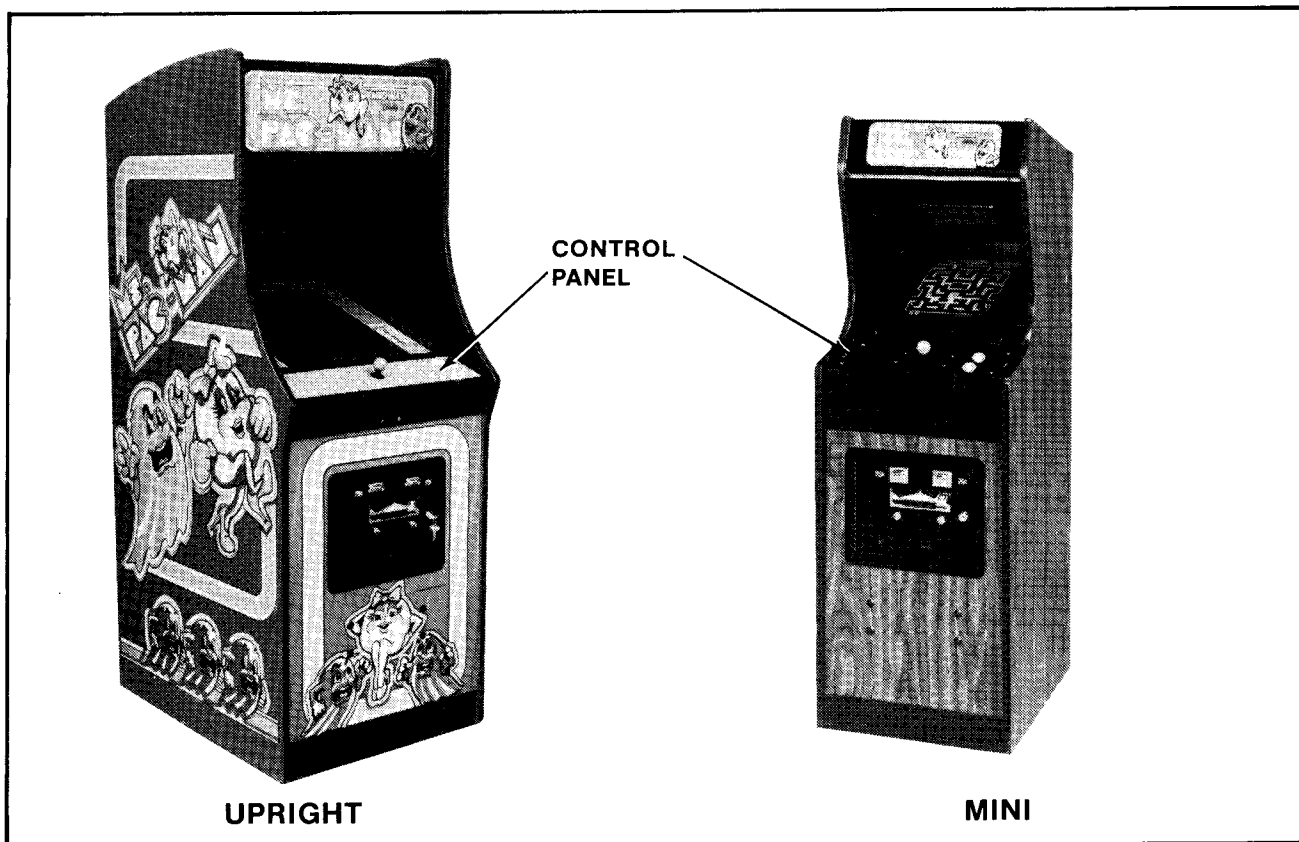

Figure 3 Major sub-assemblies (cont. from FIG 2)

After checking the line voltage in your area and determining that the input wires to the main power supply transformer of your game are connected properly — or — after obtaining a solution to your over or under voltage problem from your distributor and/or your service man, plug the game into your A.C. wall outlet.

The game ON/OFF switches for all models are located as shown in Figure 2. Turn the game on and allow it to warm up a few minutes.

Slowly open each access door to the game (this **does not** include the coin door on the Upright and Mini models).

As the door is opened approximately 1" (2.54cm) the power to the game should go off (the T.V. monitor, all the lights, and all sounds will stop).

If this does not happen, check the interlock switch by this door to see if it has broken loose from its mounting or if it is stuck in the "ON" position.

If the switch is found to be bad, turn the game off, unplug it, and replace the interlock switch. When done, plug the game back into the wall outlet, close the access door, and turn the game back on.

After the game has warmed up, repeat the above interlock switch test.

When the interlock switch is working properly and turns the power to the game off, power may be restored to the game with the access door(s) open. Take hold of the interlock switch plunger and **gently** pull it out to its fully extended position. **THIS IS TO BE USED ONLY FOR SERVICING THE GAME.** See Figure 4.

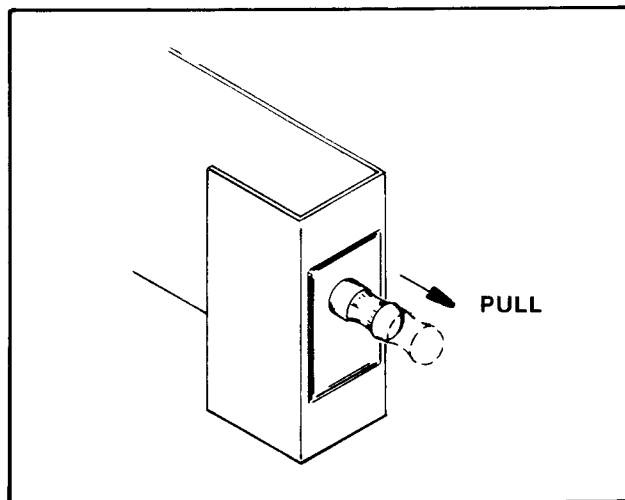

Figure 4 Interlock switch operation

SELF-TEST

Your new game will Self-Test itself to see if it has any bad parts. The information it receives while testing itself will be shown on the T.V. monitor. Some information can also be heard through the game's speaker system. See the GAME OPERATION section for a more detailed description of this function.

When there is a bad result according to the Self-Test, call your distributor and/or service man to have the trouble fixed unless it is something you can do yourself (such as replace a bad RAM or ROM chip).

GAME VOLUME ADJUSTMENT CONTROL. See Figure 5.

The game volume control pot is located on the game logic board assembly. There is only one pot. For adjustment, it may be reached through the rear access door on the Upright and Mini models. On the Cocktail Table model, you will have to open the table top to reach it.

To make the sounds louder, turn the pot in a clockwise direction (↻).

To make the sounds **less** loud, turn the pot in a counterclockwise direction (↺).

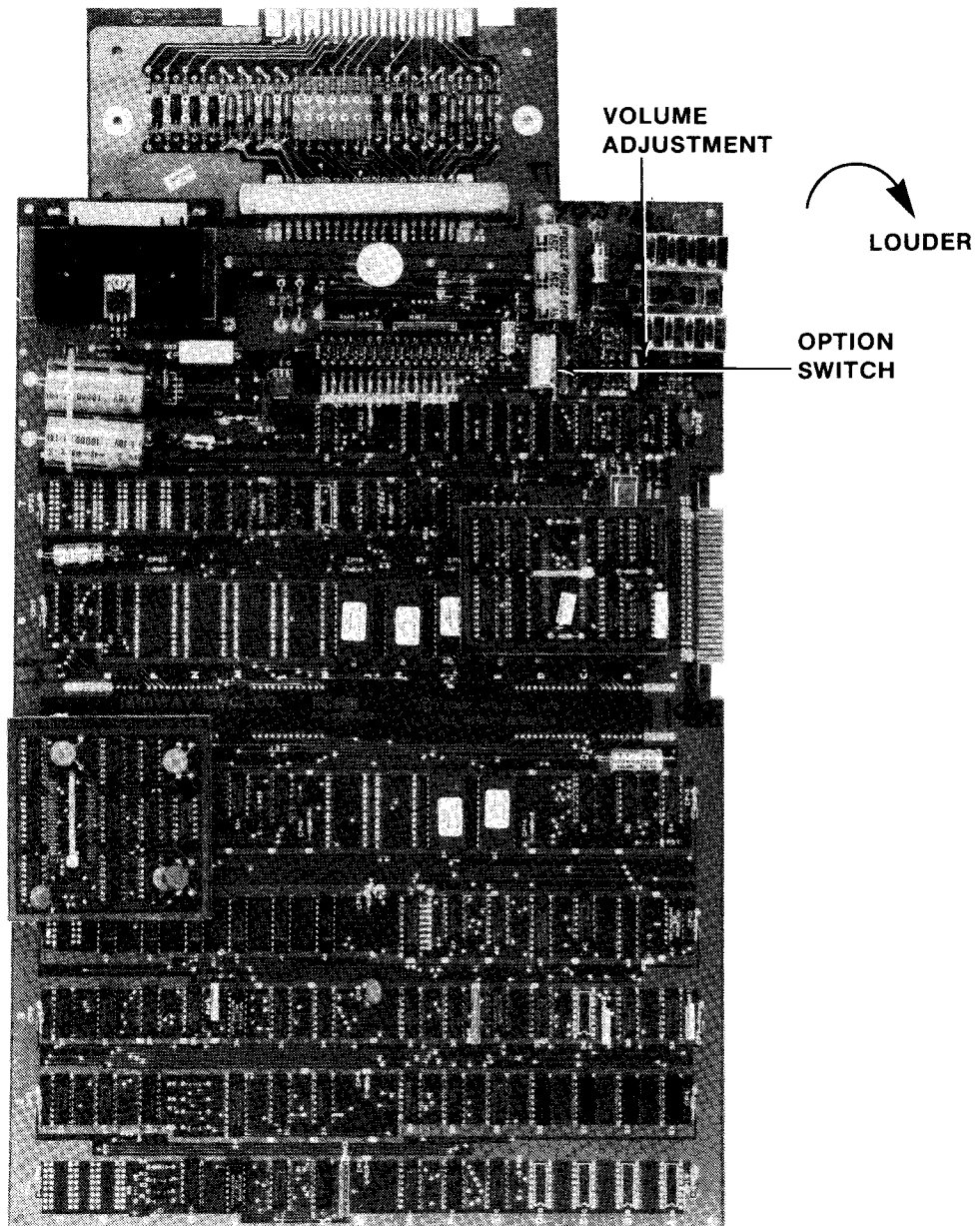

Figure 5 Location of volume control & option switch

OPTION SWITCH SETTINGS

To change the option switch settings, you DO NOT have to take the Main Game Logic Board out of the game. They can be easily reached through the rear access door on the Upright and Mini models. On the Cocktail Table model, you do have to open the table top to reach them.

When changing any options, ALWAYS put the game into the Self-Test mode, make your changes, check

the results on the monitor screen, take the game out of the Self-Test mode, and play the game to be sure the switches have worked properly and that no switches were accidentally moved that were not meant to be. (These switches are small and this can happen.)

The option switch settings and what they will make the game do are shown in Figure 6. See Figure 5 for option switch locations.

MS. PAC-MAN	
OPTION SWITCH SETTINGS	
METHOD OF PLAY	
FREE PLAY 1 COIN 1 PLAY 1 COIN 2 PLAYS 2 COINS 1 PLAY	SW#1 SW#2 SW#3 SW#4 SW#5 SW#6 SW#7 SW#8 ON ON OFF ON ON OFF OFF OFF
NUMBER OF MS. PAC-MEN PER GAME	
1 MS. PAC-MAN 2 MS. PAC-MEN 3 MS. PAC-MEN 5 MS. PAC-MEN	ON ON OFF ON ON OFF OFF OFF
BONUS MS. PAC-MEN	
BONUS MS. PAC-MAN AT 10,000 POINTS BONUS MS. PAC-MAN AT 15,000 POINTS BONUS MS. PAC-MAN AT 20,000 POINTS NO BONUS	ON ON OFF ON ON OFF OFF OFF
SPECIAL FUNCTIONS	
AUTOMATIC RACK ADVANCE FREEZE VIDEO (MONITOR PRESENTATION STOPS MOVING) GAME OPERATES NORMALLY	ON OFF OFF ON OFF OFF

Figure 6 Option switch settings

Game Operation

MS. PAC-MAN is a one or a two player game with a color T.V. monitor. The game gives a display which has all the parts shown in Figure 7.

The game has four possible modes of operation: ATTRACT, READY-TO-PLAY, PLAY, and SELF-TEST.

SELF-TEST MODE

The Self-Test mode is a special mode for checking the game switches and computer functions. It is the easiest and best way to check for proper operation of the entire game.

NOTE: Putting the game into Self-Test will cause it to **erase** any CREDITS on the game from its memory.

You may begin a Self-Test at any time by sliding the Self-Test switch to the "ON" position after the power to the game is on. The test switch is located inside the coin door under the coin meter. When this is done, the game will react as follows:

1. First, you will see random colored parts of the picture, then a moving pattern of white letters and numbers followed by moving multicolored patterns on the screen.
2. Immediately following this, a rightside up test display is shown on the monitor screen. This will remain until you set the Self-Test switch back to the "OFF" position. This test display is shown below.

SELF-TEST DISPLAY AND BOARD LOCATION COORDINATES

MEMORY OK or
(M-Rom-1/Bad C Ram-0/Bad W Ram-1/etc.)

*1 COIN *1 CREDIT

BONUS *15000

MS. PAC-MEN *3

UPRIGHT or (TABLE)

* = switch selectable

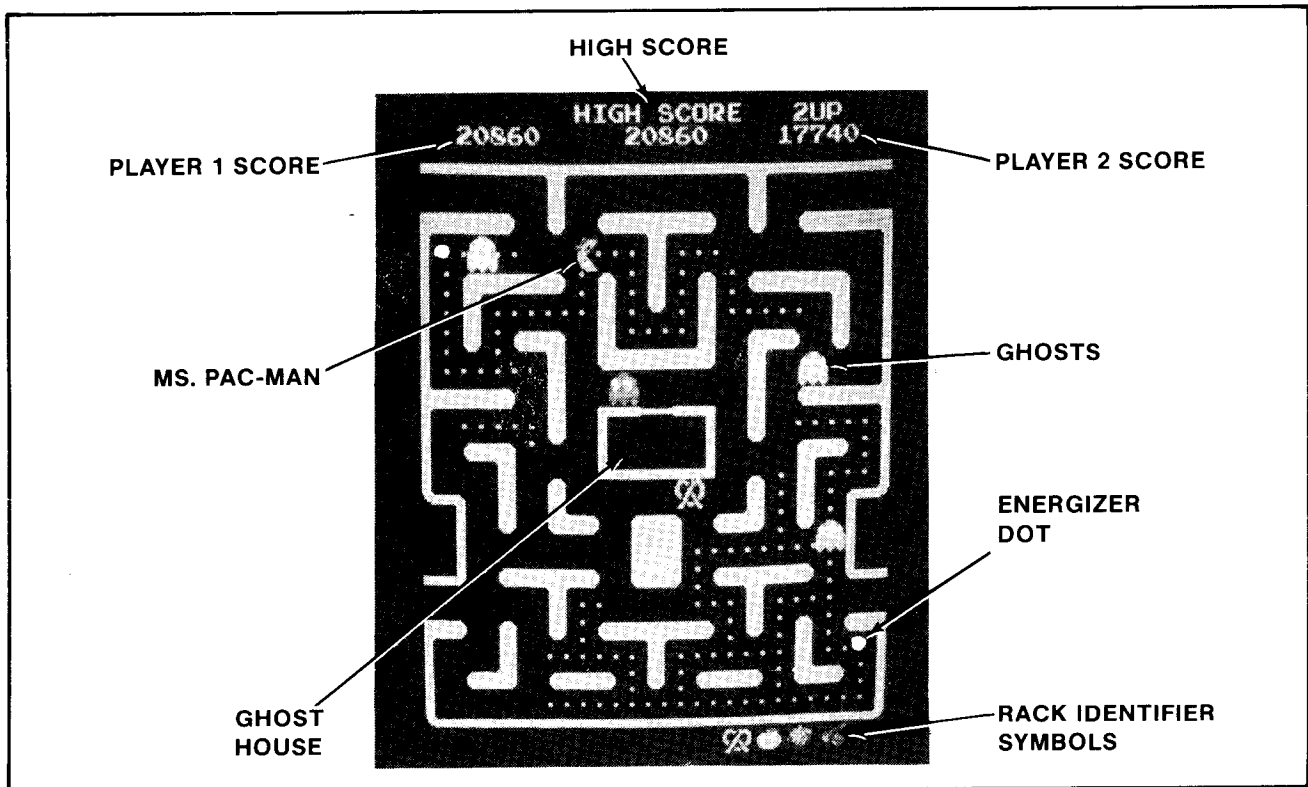

Figure 7 Identification of "on screen" graphics during play

3. If a bad ROM or RAM is found by the game's internal check system during the Self-Test, the game indicates this to you by showing the location code of the bad chip(s) in place of the

"MEMORY OK" message. The following table translates the chip location codes into actual positions on the game logic P.C. Board.

DISPLAY	DESCRIPTION
MEMORY OK BAD V RAM-0 BAD V RAM-1 BAD C RAM-0 BAD C RAM-1 BAD W RAM-0 BAD W RAM-1	All RAMs are good. RAM located on Logic PC board at position 4K is bad. RAM located on Logic PC board at position 4N is bad. RAM located on Logic PC board at position 4L is bad. RAM located on Logic PC board at position 4P is bad. RAM located on Logic PC board at position 4M is bad. RAM located on Logic PC board at position 4R is bad.
MEMORY OK M-ROM-0 M-ROM-1 M-ROM-2 M-ROM-3	All ROMs are good. ROM located on Logic PC board at position 6E is bad. ROM located on Logic PC board at position 6F is bad. ROM located on Logic PC board at position 6H is bad. ROM located on Logic PC board at position 6J is bad.

4. The detection of bad components on the Auxiliary Logic PC Board is not quite as simple as is the case for the Main Logic PC Board. The following

table lists the components that are on this Auxiliary PC Board and what symptoms they will cause to appear on the monitor when each is bad.

BAD COMPONENT	SYMPTOM DISPLAYED ON MONITOR (GAME IS NOT IN SELF-TEST)
Z-80 CPU	STATIONARY color garbage (parts of pictures) CPU located on auxiliary PC board at position U4
E-ROM-0	Game goes through warm-up routine over & over & over... ROM located on Auxiliary PC board at position U5
E-ROM-1	Game goes through warm-up routine over & over & over... ROM located on Auxiliary PC board at position U6
E-ROM-2	FLASHING color garbage (parts of pictures) ROM located on Auxiliary PC board at position U7
CUSTOM CHIP CG-820	Monitor screen reads out "ROM 0" With game in Self-Test — Screen reads "BAD ROM 0" CG-820 located on Auxiliary PC board at position U0
CUSTOM CHIP CG-821	Monitor screen displays FLASHING color garbage (parts of pictures) CG-821 located on Auxiliary PC board at position U1
CUSTOM CHIP CG-822	Screen display is same as for CG-821 With game in Self-Test — Screen reads out UPSIDEDOWN "BAD W RAM-0" CG-822 located on Auxiliary PC board at position U2
CUSTOM CHIP CG-823	Screen display is same as for CG-821 CG-823 located on Auxiliary PC board at position U3

5. To check your game function switches and buttons (coin counter switches, TEST CREDIT button, 1 PLAYER and 2 PLAYER buttons): activate each one while the game is in the Self-Test mode. You should hear a game sound for each activation. If you do not hear it, the switch/button is either not working, miswired, or disconnected. Check it out thoroughly.
 6. When finished with the Self-Test mode, slide the Self-Test switch back to the "OFF" position.
- A cross hatch pattern appears on the monitor screen for about 2 seconds.
 - If you wish to keep this test pattern on the monitor screen for further use, slide Self-Test switch back to the "ON" position **after** the cross hatch appears and **before** it disappears.
 - When finished with the cross hatch pattern, set the Self-Test switch to the "OFF" position.
 - Normal game functions will now return to the monitor screen.
-

ATTRACT MODE

1. The Attract mode starts:
 - Just after power has been turned on to the game. (Self-Test switch is in the "OFF" position.)
 - After a Self-Test has been completed. (Performing a Self-Test sets the credits in the game's memory to zero "0".)
 - After a play has been finished and there are no more credits left in the game's memory.
 - In the Attract mode, the game will give the following displays **centered** on the monitor screen:

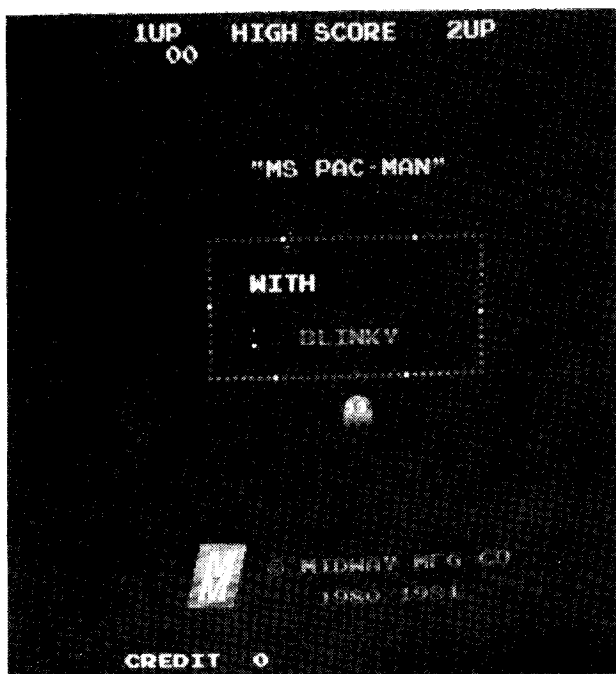

DISPLAY 1

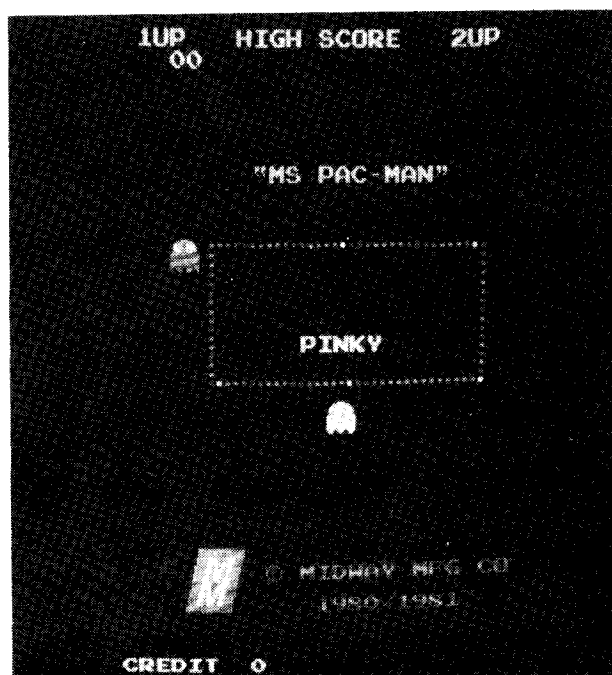

DISPLAY 2

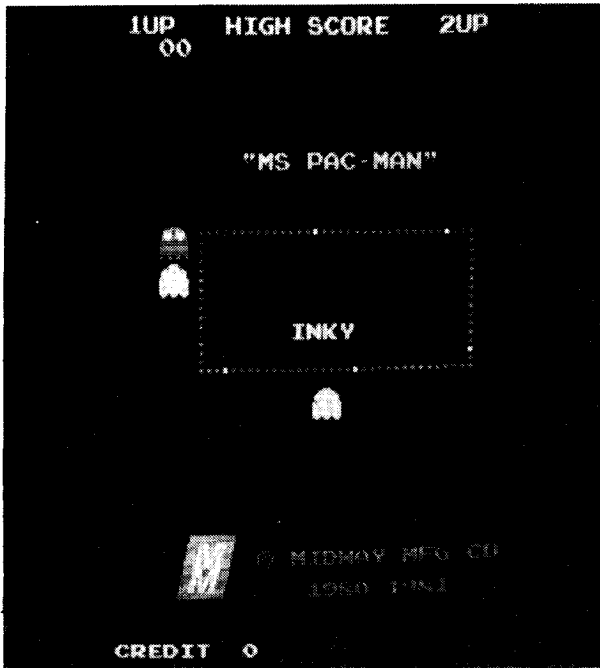

DISPLAY 3

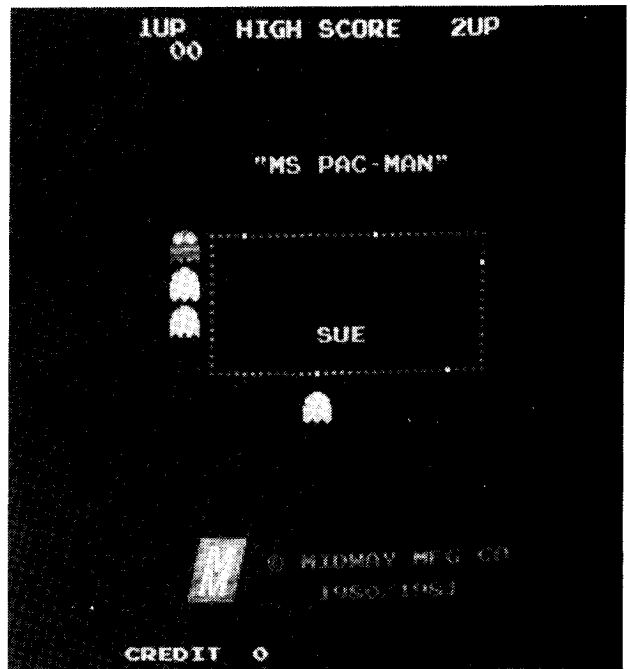

DISPLAY 4

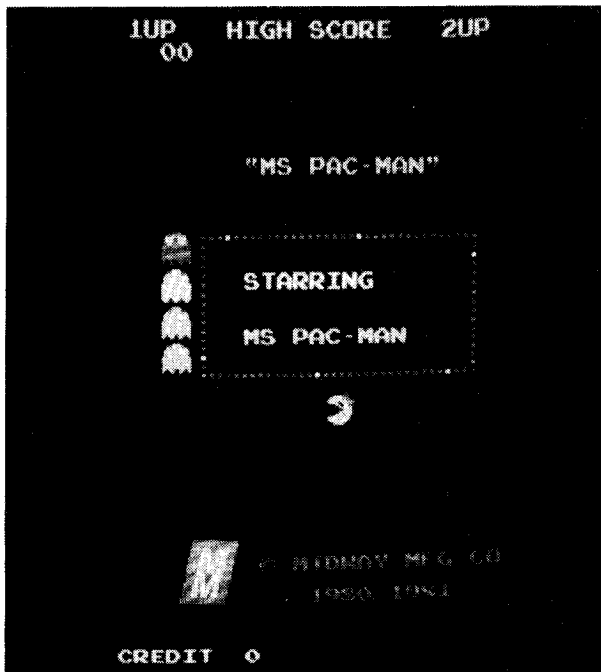

DISPLAY 5

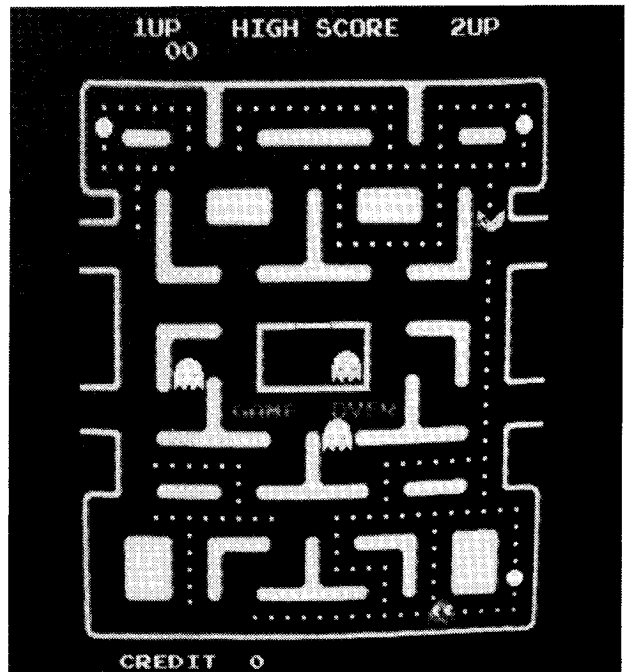

DISPLAY 6

- No matter where the game is in the Attract mode sequence, it will immediately go to the following display as soon as a game has been paid for. It will hold this display on the monitor screen until the "1 PLAYER" or the "2 PLAYER" start button is pushed.

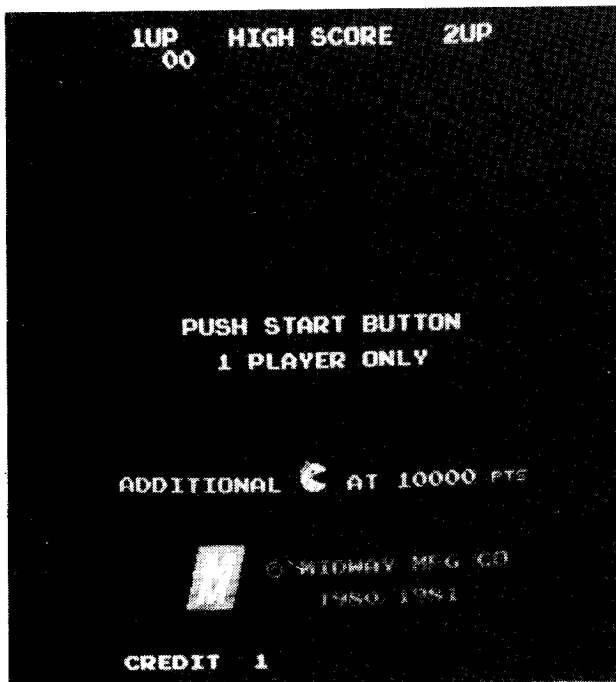

DISPLAY 1

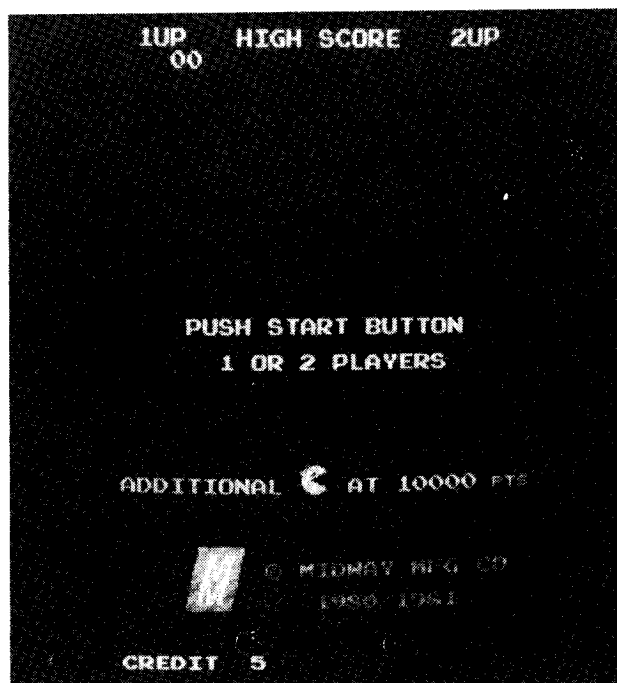

DISPLAY 2

READY-TO-PLAY MODE

1. The Ready-To-Play mode starts when enough coins have been accepted for a 1 or a 2 player game.
2. The Ready-To-Play mode ends when either the "1 PLAYER" or the "2 PLAYER" push button is pressed.
3. In the Ready-To-Play mode, the game will give one of the above displays **centered** on the monitor screen.
4. If no START button is pressed, the game will hold this display on the screen indefinitely.

PLAY MODE

1. The Play mode begins when either the "1 PLAYER" or the "2 PLAYER" start button is pressed. "READY!" is displayed below the "GHOST HOUSE" on the screen.
2. The Play mode ends when your last MS. PAC-MAN has been eliminated. When this happens, "GAME OVER" is written across the center of the monitor screen (below the "GHOST HOUSE").
3. The game consists of four different mazes. Each maze has side exits. These vary in number and location on each of the four mazes. The mazes contain small dots in most of the passageways plus four flashing ENERGIZER DOTS (one near each corner of the maze). MS. PAC-MAN just loves to eat the dots in these passageways. Each maze also has a "GHOST HOUSE" at its center — maximum capacity, three ghosts at one time. Its door is on its top side (side farthest from player).

4. At the beginning of each game, MS. PAC-MAN appears at the lower center of the maze while the four ghosts appear at the "GHOST HOUSE". BLINKY appears outside the door and PINKY, INKY, and SUE appear inside the "GHOST HOUSE".
5. When play begins, BLINKY (who'd love to eliminate her) immediately begins looking for MS. PAC-MAN (who immediately begins eating dots just as fast as she can). As time passes, PINKY, INKY, and SUE (who'd also love to eliminate her) leave the "GHOST HOUSE" one at a time and begin looking for MS. PAC-MAN — who is still busily eating dots just as fast as **YOU** can steer her to them.

NOTE: If MS. PAC-MAN eats a maze identifier symbol as it comes wandering through the maze, its point value is immediately added to your score.

But with all four ghosts chasing her, it is not as easy to eat the dots (without being eliminated by a ghost) as it was earlier in the game. And BLINKY, PINKY, INKY, and SUE are four **VERY SMART** ghosts. For instance, they will divide up two, three, or four ways to try to trap MS. PAC-MAN between them, in a corner, or even in one of the tunnels. You've really got to watch them! It seems like they always have some sneaky new trick up their sleeves.

However, if they get too close, MS. PAC-MAN can always eat one of the flashing ENERGIZER DOTS. When this happens, it causes all four ghosts to turn blue with fright no matter where

they are in the maze. This is because they know that when she eats an ENERGIZER DOT it gives MS. PAC-MAN the ability to eliminate them. But, she can **ONLY** eliminate them for as long as they are blue. And they will only stay blue for a short period of time. But the ghosts do give a warning **BEFORE** they turn back to their original colors — they start to flash.

When MS. PAC-MAN eliminates a blue ghost, its point value appears on the monitor screen at the place where the ghost was eliminated while at the same time being added to your score, and the ghost disappears — all except for its eyes. The eyes go back to the “GHOST HOUSE” where they get another body of their original color. This done, they leave the “GHOST HOUSE” again and take up their pursuit of MS. PAC-MAN once more.

When she eats the last dot of any particular maze: all movement stops immediately, the maze flashes, and the next maze appears. All the players are in the new maze when it appears. The word “READY!” is also there — right below the “GHOST HOUSE”. After a second or two passes, the word “READY!” disappears and play begins.

You **MUST** eat all the dots in any particular maze in order to advance to the next one.

The maze identifier symbols appear at the bottom edge of the monitor screen.

As your skill level increases, the four ghosts speed up their pursuit of MS. PAC-MAN and they stay blue for **shorter and shorter** periods of time after she eats an ENERGIZER DOT until, in the high number mazes, they do not turn blue at all.

One bonus player (this is switch selectable) can be awarded to you as you reach or pass a certain preselected point value. The assigned point values for all items that can be eaten are as listed in Figure 1.

When one of the ghosts happens to eliminate one of your MS. PAC-MEN, assuming you have at least one remaining in reserve, the word “READY!” appears below the “GHOST HOUSE” at the same time one of your reserve MS. PAC-MEN appears at the lower center part of the maze. After a second or two passes, the word “READY!” disappears and play begins anew.

When one of the ghosts eliminates your **LAST** MS. PAC-MAN, the words “GAME OVER” are displayed below the “GHOST HOUSE”, your score is displayed under “1 UP”, and in addition, if your score was the highest on this game to date, it will also be displayed under “HIGH SCORE” at the top center of the monitor screen. The game will then either go into the Ready-To-Play mode (if there are still credits left in its memory) or into the Attract mode (if there are no more credits left in its memory).

Most of the above holds true in the “2 PLAYER” mode also. But there are a few minor differences.

TWO PLAYER OPERATION

The Upright, Mini, and Cocktail Table models all have two player operation.

In the two player mode, the rules of play are the same as in the single player mode. There are some additional rules, however.

1. In the Upright and Mini models, the players must take turns at the controls.
2. In the Cocktail Table model, each player has his own set of individual controls. The picture will flip to face you when it is your turn. (When it is not your turn, your set of controls will have **NO** effect on the game.)
3. Your turn lasts until one of the ghosts eliminates your MS. PAC-MAN. At this point, the game will do one of several things depending on whether or not the eliminated MS. PAC-MAN was your last or if you still have others remaining in reserve.

MS. PAC-MAN ELIMINATED — OTHERS REMAINING IN RESERVE

- The chase stops.
- Next, the screen display changes to the screen display of the other player, it displays “READY!” under the “GHOST HOUSE” at the same time one of the other player’s reserve MS. PAC-MEN appears at the lower center of this maze.
- After a second or two passes, the word “READY!” disappears and play begins for the other player.

MS. PAC-MAN ELIMINATED — NO OTHERS REMAINING IN RESERVE

- Game displays the words “PLAYER ONE” or “PLAYER TWO” above the “GHOST HOUSE” and the words “GAME OVER” below the “GHOST HOUSE”.
- Your final score is displayed under “1 UP” or “2 UP”, depending upon which player you were. In addition, if your score was the highest on this game to date, it will also be displayed under “HIGH SCORE” at the top center of the monitor screen.
- After this, the screen display changes to the screen display of the other player, it displays “READY!” under the “GHOST HOUSE” at the same time one of the other player’s reserve MS. PAC-MEN appears at the lower center of this maze.
- After a second or two passes, the word “READY!” disappears and play begins for the other player.

III. Maintenance and Repair

Your **NEW** game needs certain types of maintenance to keep it in good working order. **CLEAN, well MAINTAINED** games **attract players** and **EARN MORE PROFITS.**

The most important thing for you to remember is to run the Self-Test **EVERY TIME** you collect money from the coin box. **JUST LOOKING** at your game **WILL NOT** tell you if all its controls and inside parts are working correctly. The Self-Test will inform you whether or not your game is working the way it should.

The second most important thing you should remember is to clean the outside of the game and coin acceptor mechanisms on a regular basis.

CLEANING

The outside of the game cabinet plus the metal can be cleaned with any non-abrasive household cleaner. However, the front of the T.V. monitor tube and **both sides** of all other glass and plastic on or in the game **MUST** be cleaned with anti-static cleaner **ONLY.** For cleaning the coin acceptors, hot soapy water may be used on the plastic ones and any household cleanser may be used on the metal ones. If you wish, special coin machine cleaners that leave no residue may be purchased from your distributor.

DO NOT dry-wipe any of the plastic panels. This is because any dust that was on them can scratch their surfaces. If this has happened, anyone looking

through this type of damaged plastic would feel he was looking at the game through a fog. This fogging damage **CAN NOT** be repaired or reversed. The **ONLY** solution is to **replace** the damaged piece of plastic.

FUSE REPLACEMENT

This game contains several fuses located as shown in Figure 8.

1. UPRIGHT MODEL:

As viewed from the back, facing the cabinet, with the rear access door removed; the fuses are located on the Transformer Board Assembly.

2. MINI MODEL:

As viewed from the back, facing the cabinet, with the rear access door removed; the fuses are located on the Transformer Board Assembly.

3. COCKTAIL TABLE MODEL:

As viewed from the coin door side of the cabinet, with the monitor tilted open to one side; the fuses are located on the Transformer Board Assembly.

Replace fuses **ONLY** with the type and size listed in the Illustrated Parts Breakdown Section of this manual.

See the T.V. Monitor Manual (available on request from your distributor or monitor manufacturer) and/or the T.V. Troubleshooting Section of this manual for information on these fuses.

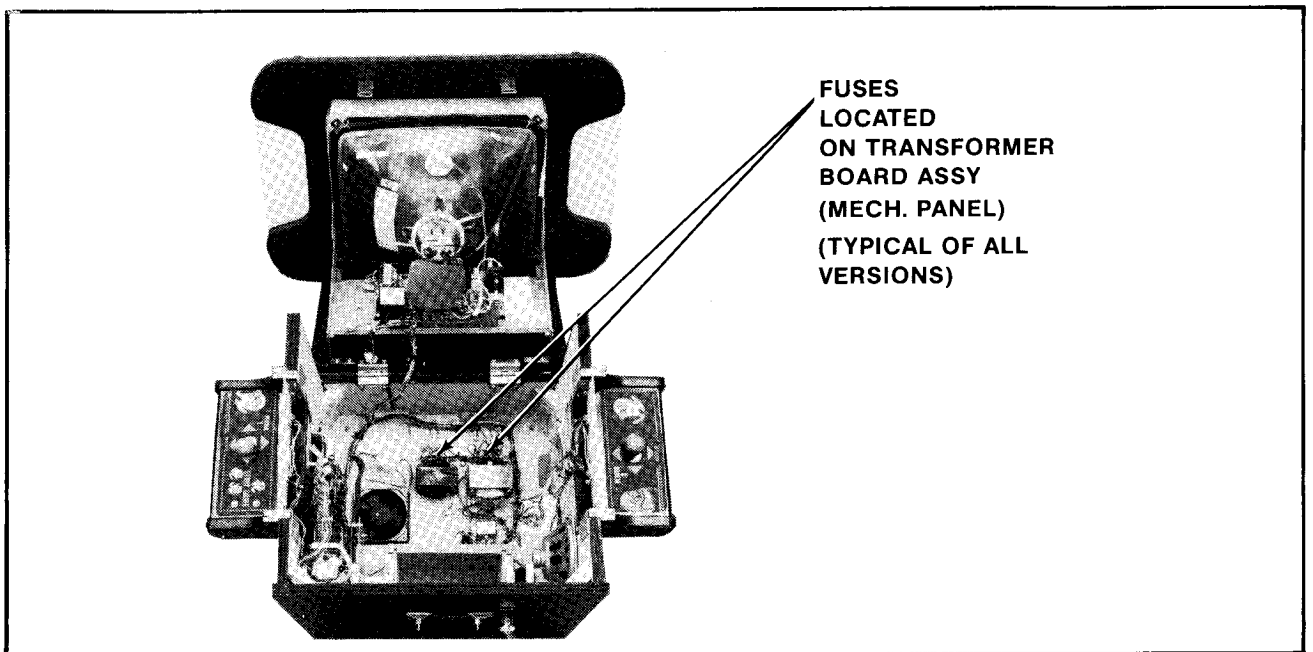

Figure 8 Location of fuses

OPENING THE CONTROL PANEL. See Figure 9.

1. UPRIGHT MODEL:

- The control panel is held in place by three latches, one on the left side, one on the right side, and one on the front center. They are spring loaded to provide constant positive pressure on their latch plates. They can be reached through the coin door **AFTER turning power to the game off.** To release the latches, lift up and toward the center of the control panel. Once they are released, unhook them from their latch plates.
- To remove the control panel: Raise it up and tilt it toward you until you can see the cable behind it. Cradling the control panel between yourself and the cabinet, disconnect it from its cabling. The control panel is now free and can be removed.
- To reinstall the control panel, reverse this procedure.

2. MINI MODEL:

- The control panel is held in place by two latches, one on the right side and one on the left side of the cabinet. They are spring loaded to provide constant positive pressure on their latch plates. They can be reached through the coin door **AFTER turning power to the game off.** To release the latches, lift up and toward the center of the control panel. Once they are released, unhook them from their latch plates.
- To remove the control panel: Raise it up and tilt it toward you until you can see the cable behind it. Cradling the control panel between yourself and the cabinet, disconnect it from its cabling. The control panel is now free and can be removed.
- To reinstall the control panel, reverse this procedure.

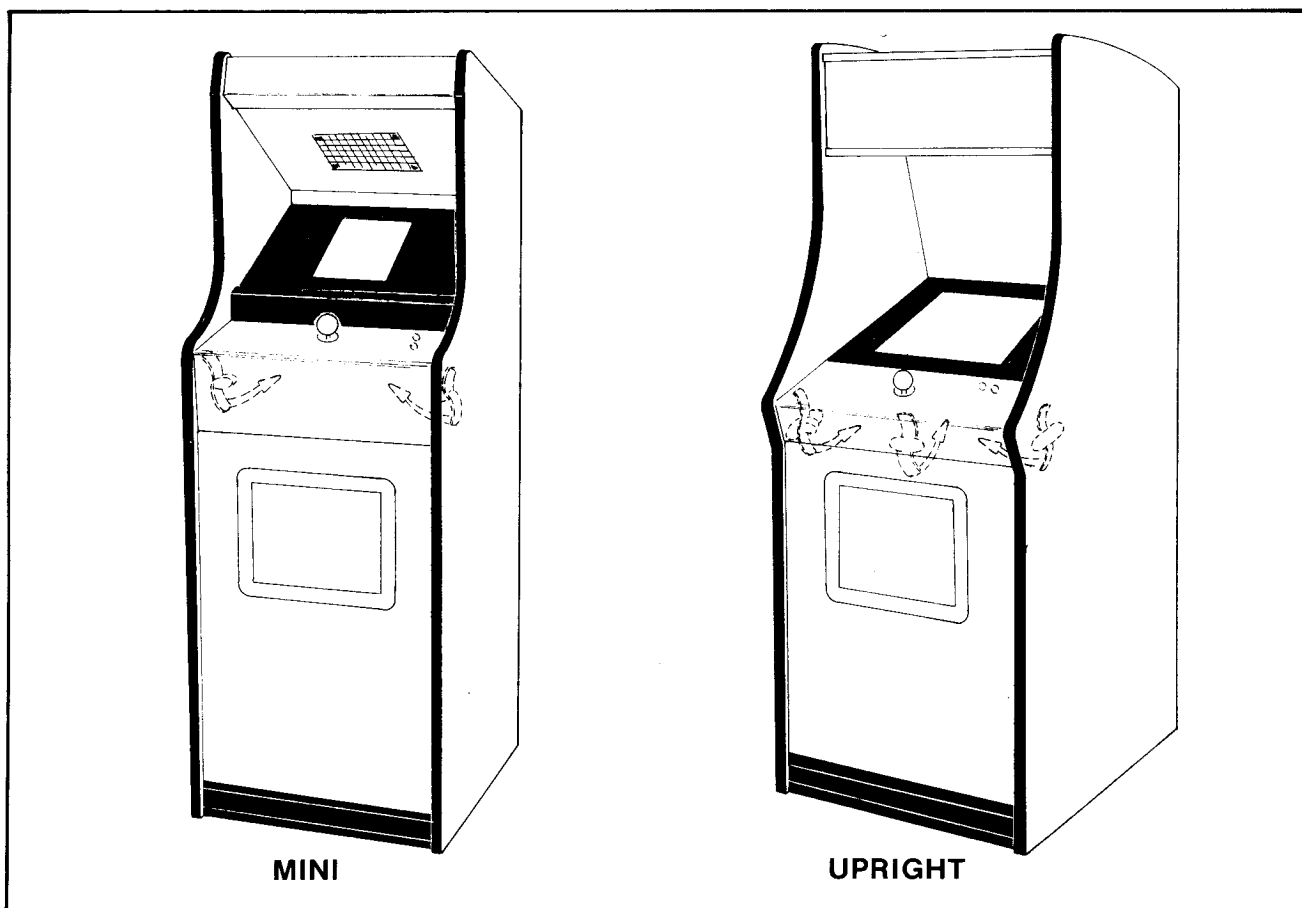

Figure 9 Removing control panel — Upright & Mini games

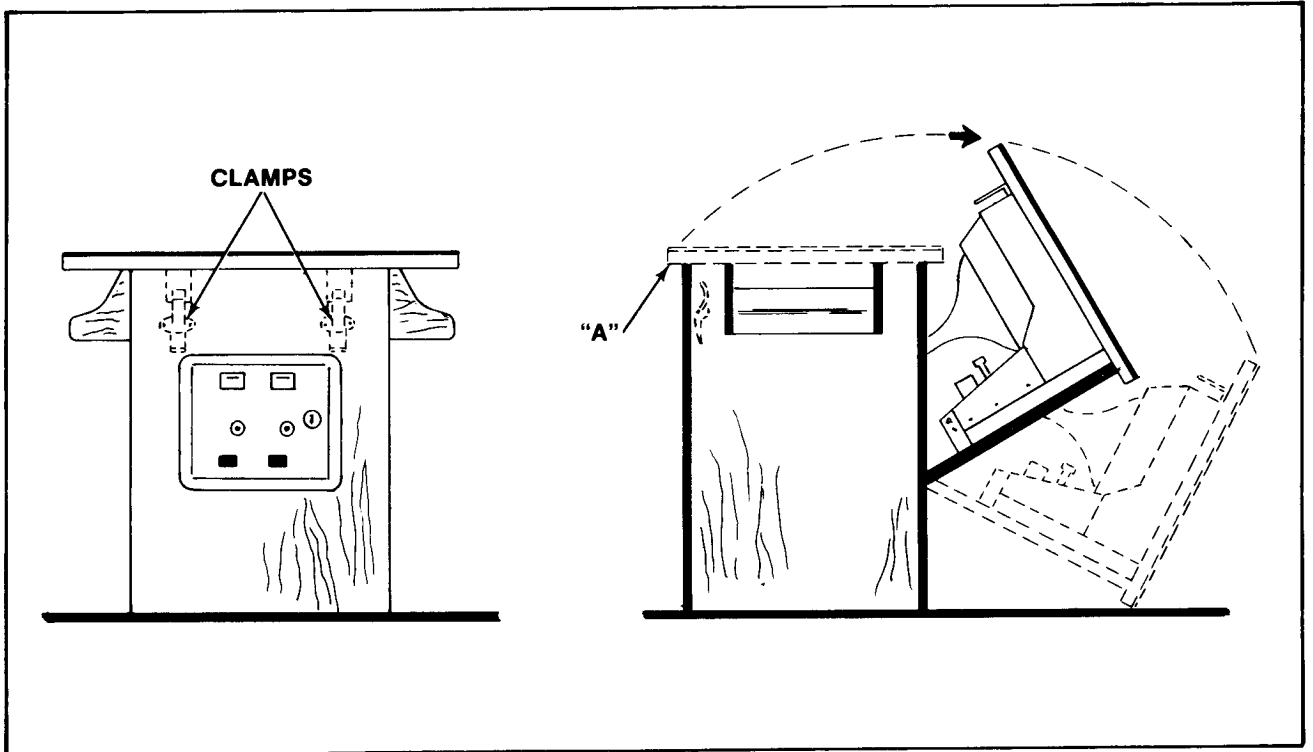

Figure 10 Opening Cocktail game

3. COCKTAIL TABLE MODEL:

- Each control panel is held in place by several screws, two on the inside of the cabinet and three along the outside bottom edge of the control panel.

Turn power to the game off.

Open the coin box door and release the two latches indicated in Figure 10.

CAUTION: The right hand latch is very close to the HIGH VOLTAGE on the monitor.

Once they're released, unhook them from their latch plates.

Grasp the table top at "A" and open it as indicated in Figure 10.

CAUTION: Due to the weight of the monitor, EXTREME CARE MUST be taken when opening the cabinet.

Remove the screws which secure the control panel in place. See Figure 11.

- To remove the control panel(s):
Disconnect it from its cabling.
The control panel is now free and can be removed.
- To reinstall the control panel, reverse this procedure.

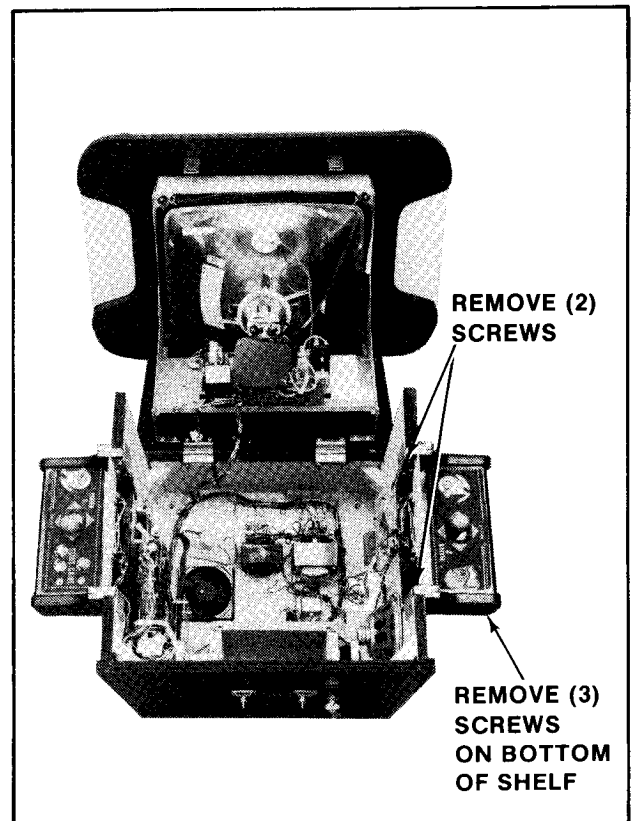

Figure 11 Removing control panel — Cocktail game

REMOVAL OF THE MAIN-DISPLAY-GLASS AND/OR THE T.V. BEZEL ASSEMBLY

1. UPRIGHT MODEL: See Figure 12.

NOTE: To do this, the latches which secure the control panel **MUST** be released. The control panel need not be removed. See the "UPRIGHT MODEL" procedure.

- Turn the power to the game off and remove the rear access door.
- Remove the screws from the glass support bracket and lift it out the back of the cabinet.
- Grasp the main-display-glass in the top center, lift up slightly and pull it out the rear of the cabinet.
- Loosen the screws which secure the T.V. bezel-glass-clamps in place. Move the clamps to the side and the bezel glass may be removed. Remove the above mentioned screws and the bezel with four bezel-glass-clamps may be removed.
- To reinstall the T.V. bezel assembly and the main-display-glass, reverse this procedure.

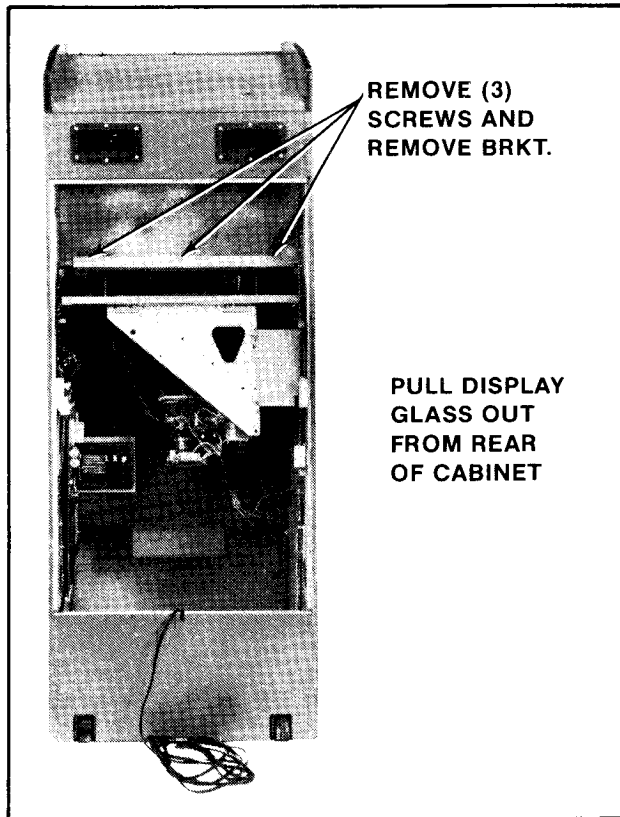

Figure 12 Removing display glass — Upright game

2. MINI MODEL: See Figure 13.

NOTE: In order to do this, the control panel **MUST** be removed first. See the "MINI MODEL" procedure.

- Turn the power off to the game and remove the control panel.
- Remove the screws which secure the glass clamping plate.
- Lift out the glass clamping plate. This frees the main-display-glass so it can be lifted up.
- By putting your finger in the hole in the middle of the main-display-glass support, you can lift it up and out.
- Remove the screws which secure the T.V. bezel assembly and lift it out.

NOTE: Use the hole in the center of the main-display-glass support to grasp it.

- Reverse this procedure to reinstall the T.V. bezel assembly and the main-display-glass.

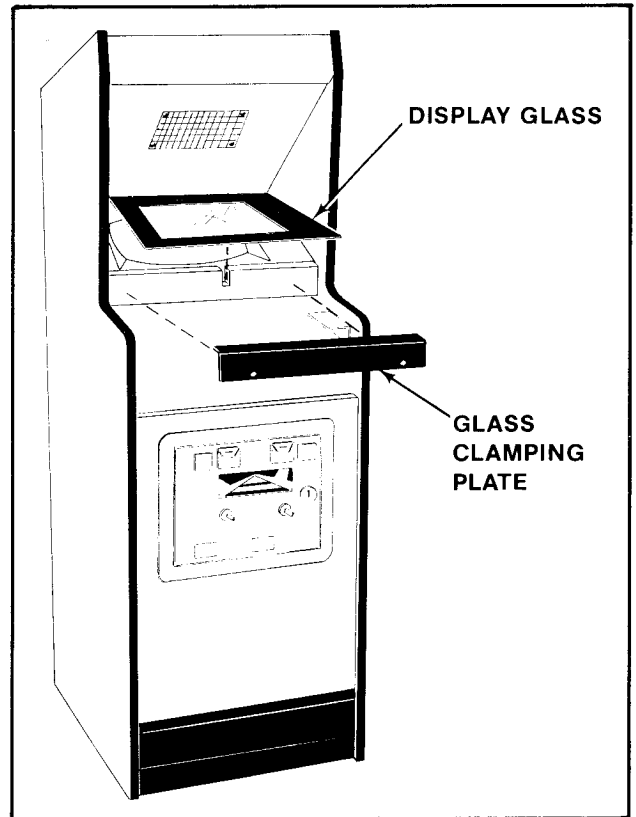

Figure 13 Removing display glass — Mini game

3. COCKTAIL TABLE MODEL: See Figure 14.

NOTE: This may be done with the table top in the open or closed position. If you decide to open the table top, **TURN THE POWER TO THE GAME OFF FIRST.**

- Remove the screws which secure the table top glass clamps in place.
- Remove the table top glass.
- Lift out the T.V. bezel assembly.
- To reinstall the T.V. bezel assembly and the table top glass, reverse this procedure.

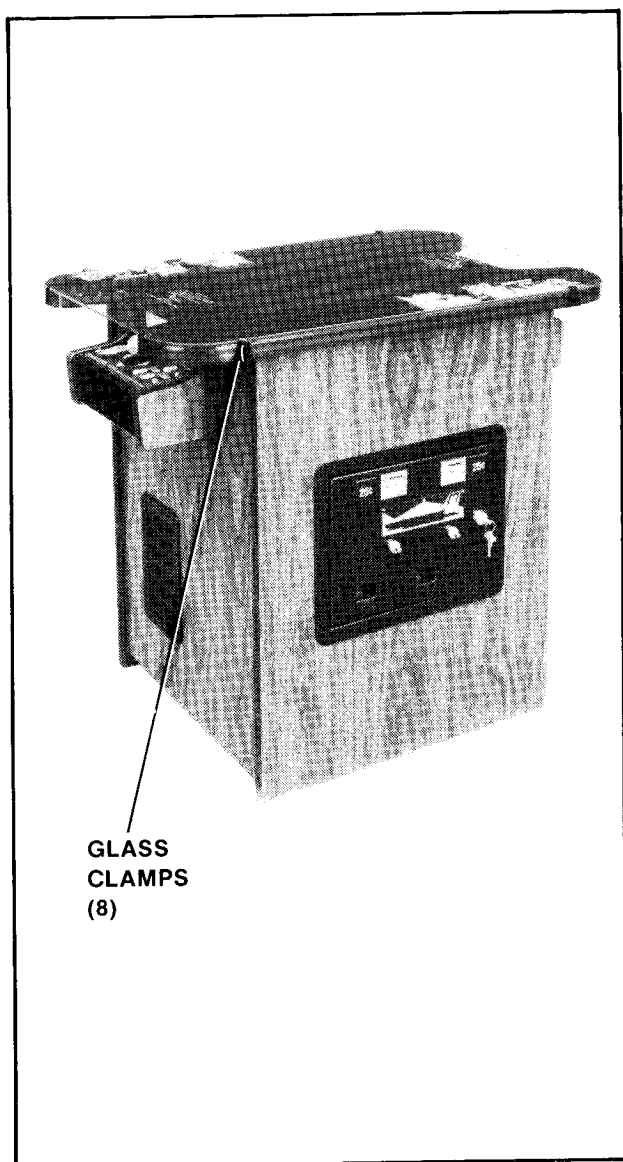

Figure 14 Removing top glass — Cocktail game

T.V. MONITOR REPLACEMENT

CAUTION: High voltages may exist in any television unit, even with the power disconnected. Use EXTREME CAUTION and do not touch electrical parts or the T.V. yoke area with your hands or with metal objects held in your hands!

In addition, BE SURE TO USE HEAVY GLOVES when handling the monitor. You could cut your hands on the metal T.V. chassis without such protection.

DANGER: The T.V. monitor DOES NOT contain an isolation transformer on its chassis (it is mounted instead on the floor of the cabinet). When servicing the monitor on a test bench, YOU MUST ISOLATE THE MONITOR FROM AC VOLTAGE WITH AN ISOLATION TRANSFORMER.

1. UPRIGHT MODEL: See Figure 15.

- Turn power off to the game.
- Open the rear access door.
- Completely disconnect the T.V. monitor from all its cabling. **DON'T FORGET THE CHASSIS GROUND WIRE.**

Before removing the T.V. monitor, the main-display-glass and bezel **MUST** be removed. See above "Upright Model" procedure.

With the removal of only four bolts, the T.V. monitor and its mounting channels will be loose.

The monitor mounting channels slide on top of and against two metal guides mounted to the cabinet's right and left sides. The monitor is removed by sliding it out the back of the cabinet. See Figure 15.

To reinstall the T.V. monitor, reverse this procedure.

After replacing the T.V. monitor, be sure to run the game Self-Test.

2. MINI MODEL: See Figure 16.

Turn the power off to the game.

Open the rear access door.

Completely disconnect the T.V. monitor from all its cabling. **DON'T FORGET THE CHASSIS GROUND WIRE.**

Before removing the T.V. monitor, the main-display-glass and bezel **MUST** be removed. See above "Mini Model" procedure.

With the removal of only four nuts, the T.V. monitor will be loose.

CAUTION: BE SURE to support the T.V. monitor from the rear while removing the four bolts so it will not fall out of the cabinet.

The monitor is removed by supporting it and pulling straight back as shown in Figure 16.

To reinstall the T.V. monitor, reverse this procedure.

After replacing the T.V. monitor, be sure to run the game Self-Test.

3. COCKTAIL TABLE MODEL: See Figure 18.

Turn power off to the game.

Open the coin box door and release the two latches indicated in Figure 17.

CAUTION: The right hand latch is very close to the HIGH VOLTAGE on the monitor.

- Once the latches are released, unhook them from their latch plates.
- Grasp the table top at "A" and open it as indicated in Figure 17.

CAUTION: Due to the weight of the monitor, EXTREME CARE MUST be taken when opening the cabinet.

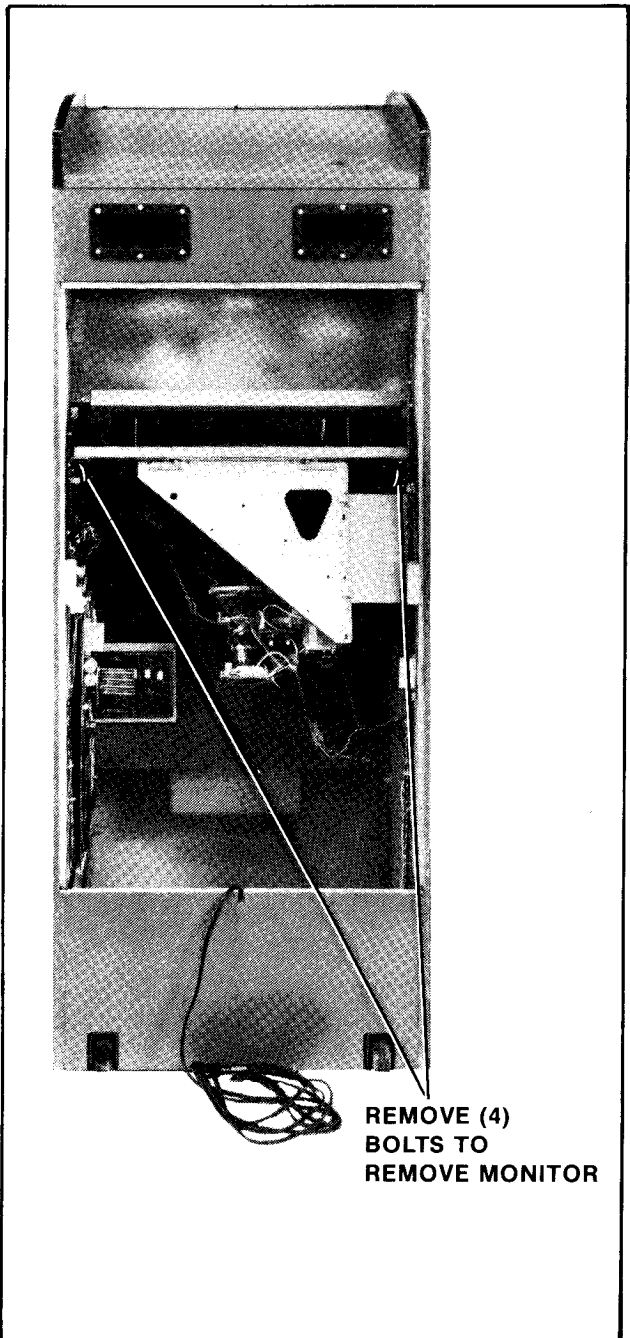

Figure 15 Removing monitor — Upright game

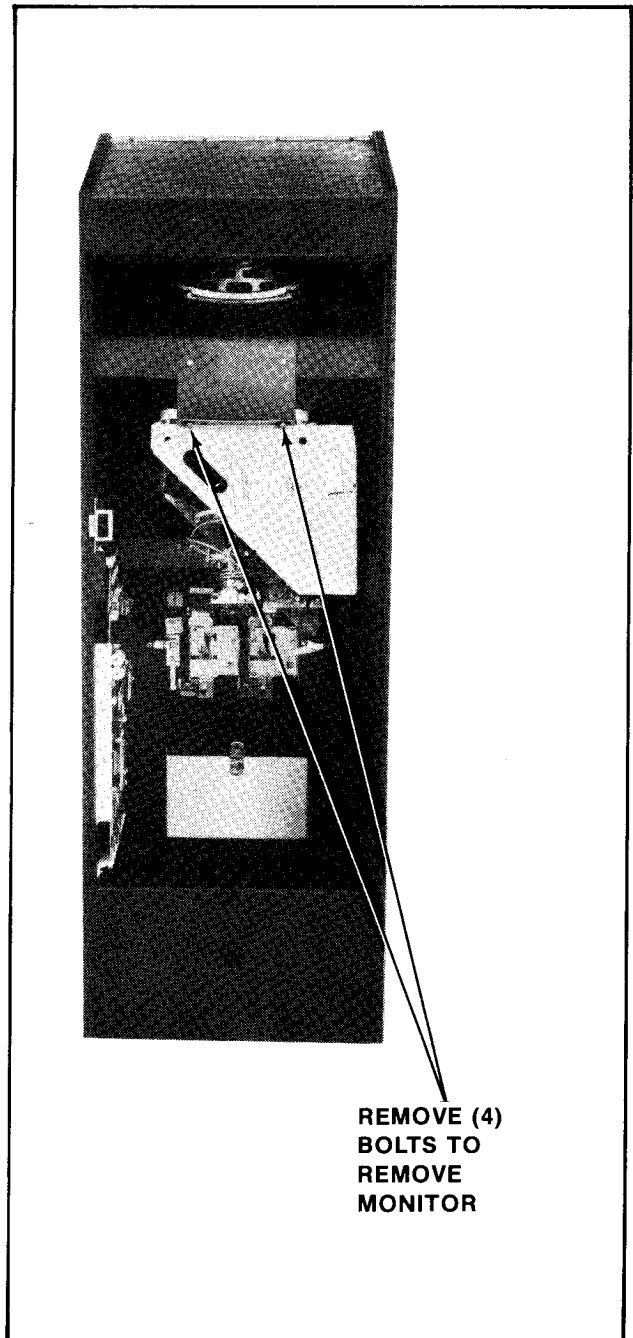

Figure 16 Removing monitor — Mini game

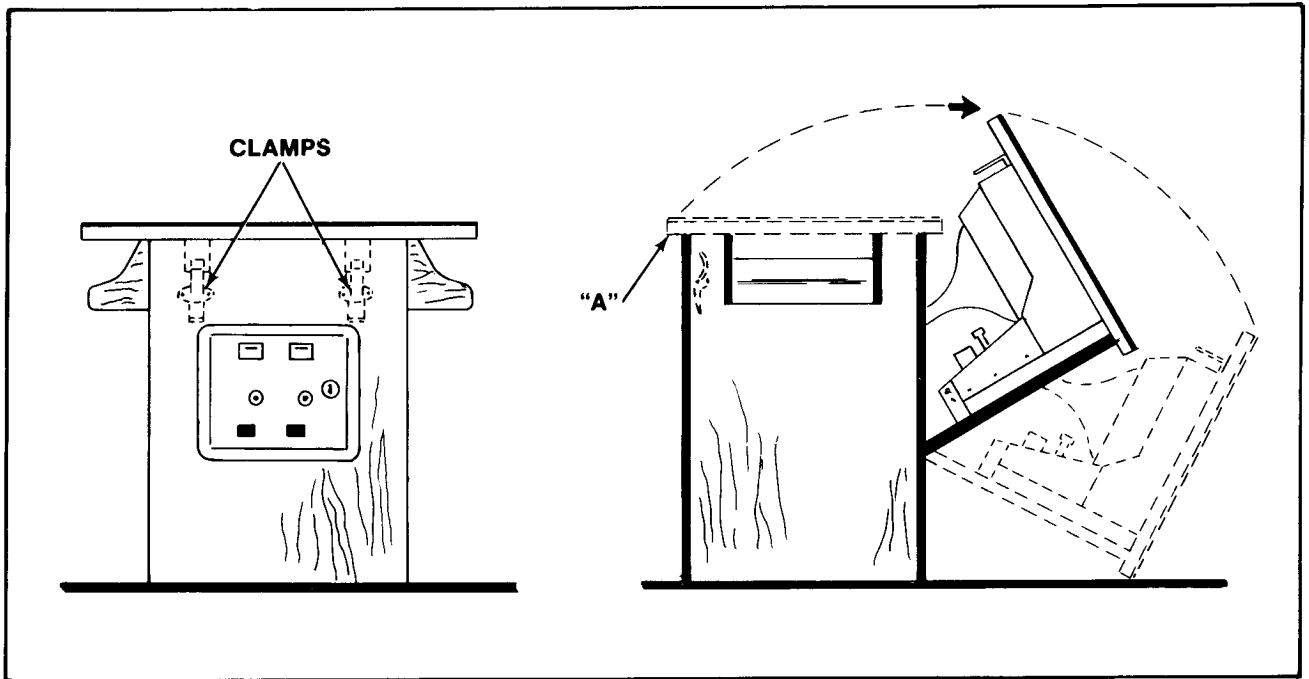

Figure 17 Opening Cocktail game

- Remove the screws which hold the table top glass clamps in place.
- Remove the table top glass.
- Lift out the T.V. bezel assembly.
- Completely disconnect the T.V. monitor from all its cabling. **DON'T FORGET THE CHASSIS GROUND WIRE.**
- Remove the screws holding the T.V. monitor chassis to the "L" by the door hinge(s). See Figure 18.
- Close the Cocktail Table top and re-latch it.
- Remove the screws which secure the T.V. monitor mounting brackets to the edges of the slot cut in the table top. See Figure 18.
- Pry up the end of each monitor mounting bracket with a screwdriver or similar tool until you can grasp them both.
- Lift the T.V. monitor straight up and out of the table top being **VERY CAREFUL** not to bump the neck of the picture tube.
- To reinstall the T.V. monitor, reverse this procedure.
- Be sure to check the clearance of the "L" brackets **BEFORE** setting the monitor into the table top.
- After replacing the T.V. monitor, be sure to run the game Self-Test.

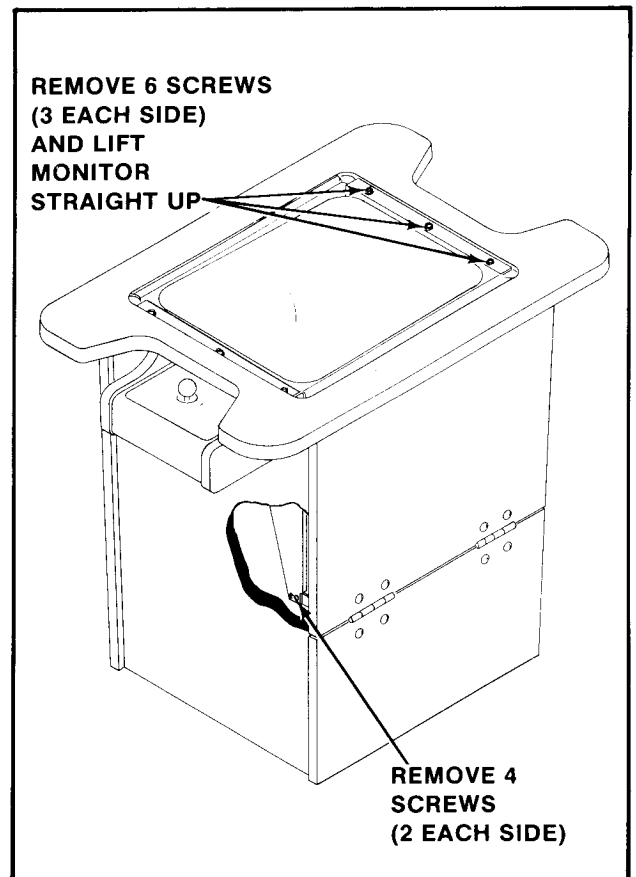

Figure 18 Removing monitor — Cocktail game

PRINTED CIRCUIT BOARD (P.C.B.) REPLACEMENT

1. UPRIGHT MODEL: See Figure 19.

- Turn the power to the game off.
- Unlock and open the rear access door.
- Disconnect the Main Game Logic Board from all its cabling.
- Disconnect the Auxiliary Game Logic Board from the Main Game Logic Board.
- Remove the P.C.B. clamps indicated in Figure 19 and slide the Main Game Logic Board out the back of the cabinet.
- **CAREFULLY** pop the Auxiliary Game Logic Board off its four snap-in mounting posts and lift it out the back of the cabinet.
- To reinstall the above P.C.B.'s, reverse this procedure.

NOTE: All P.C.B. connectors are keyed and will **ONLY** fit one way without forcing them. The plugs on the cable harness which connect it to the P.C.B.'s are also keyed and will **ONLY** go onto their connectors one way without forcing them.

2. MINI MODEL: See Figure 19.

- Turn the power off to the game.
- Unlock and open the rear access door.
- Disconnect the Auxiliary Game Logic Board from the Main Game Logic Board.
- Remove the P.C.B. clamps indicated in Figure 19 and slide the Main Game Logic Board out the back of the cabinet.
- **CAREFULLY** pop the Auxiliary Game Logic Board off its four snap-in mounting posts and lift it out the back of the cabinet.
- To reinstall the above P.C.B.'s, reverse this procedure.

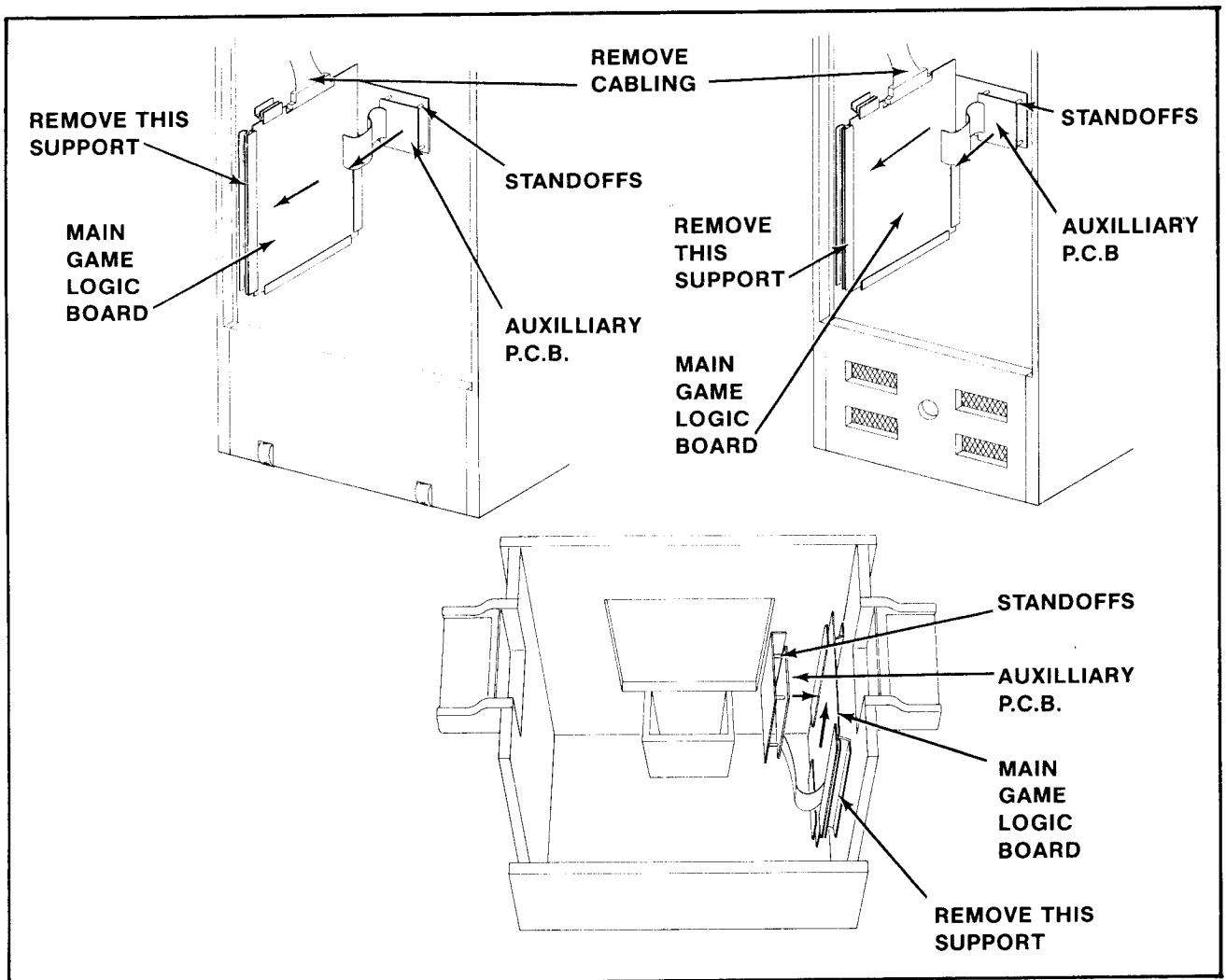

Figure 19 Removing printed circuit boards

3. COCKTAIL TABLE MODEL: See Figure 19.

- **Turn the power off to the game.**
- Open the cabinet:
Open the coin box door and release the two latches indicated in Figure 17.

CAUTION: The right hand latch is very close to the HIGH VOLTAGE on the monitor.

Once they're released, unhook them from their latch plates.

- Grasp the table top at "A" and open it as indicated in Figure 17.

CAUTION: Due to the weight of the monitor, EXTREME CARE MUST be taken when opening the cabinet.

- To remove the Main and Auxiliary Game Logic Boards. See Figure 19.
Disconnect the Auxiliary Game Logic Board from the Main Game Logic Board.
Remove the P.C.B. clamps indicated in Figure 19 and slide the Main Game Logic Board out of the cabinet.
CAREFULLY pop the Auxiliary Game Logic Board off its four snap-in mounting posts and lift it out of the cabinet. See Figure 19.
- To reinstall the above P.C.B.'s, reverse this procedure.

OPENING THE ATTRACTION PANEL

1. UPRIGHT MODEL: See Figure 20.

- **Turn the power to the game off.**
- Opening the attraction panel:
Remove the screws which secure the top bracket in place. (They are on its top side.) See Figure 20.
Remove the top bracket and slide up the attraction panel. This exposes the attraction panel fluorescent light tube and its mounting bracket assembly. See Figure 20.
To reinstall the attraction panel, reverse this procedure.
- The fluorescent light tube may be replaced at this time. **BE CAREFUL NOT TO DROP IT.**

WARNING: If you drop a fluorescent tube and it breaks, IT WILL IMplode! Shattered glass can fly six (6) feet or more from the implosion. Use care when replacing any fluorescent tube.

- Replacing the fluorescent tube starter. See Figure 21.
Be sure the power to the game has been turned off.

Grasp the starter (it is on the back of the mounting bracket), give it a quarter turn, and remove it from its socket.

To replace the fluorescent light tube starter, reverse this procedure.

- Replacement of the fluorescent tube mounting bracket assembly. See Figure 22.
Be sure the power is off to the game.
Disconnect it from its power cable.
Remove the screws at its right and left hand sides which secure it and gently slide it out the front of the cabinet, being careful not to catch its power cable on anything.
To reinstall the fluorescent tube mounting bracket assembly, reverse this procedure.
- Replacing the speaker. See Figure 22.
Be sure the power is off to the game.
Remove the attraction panel and disconnect the speaker from its cabling.
Remove the nuts and bolts which secure the speaker and speaker grill in place and set them and the speaker grill aside.
Once the bolts which secure the speaker in place are removed, the speaker may be removed through the opening where the attraction panel was.
Reverse this procedure to reinstall the speaker.

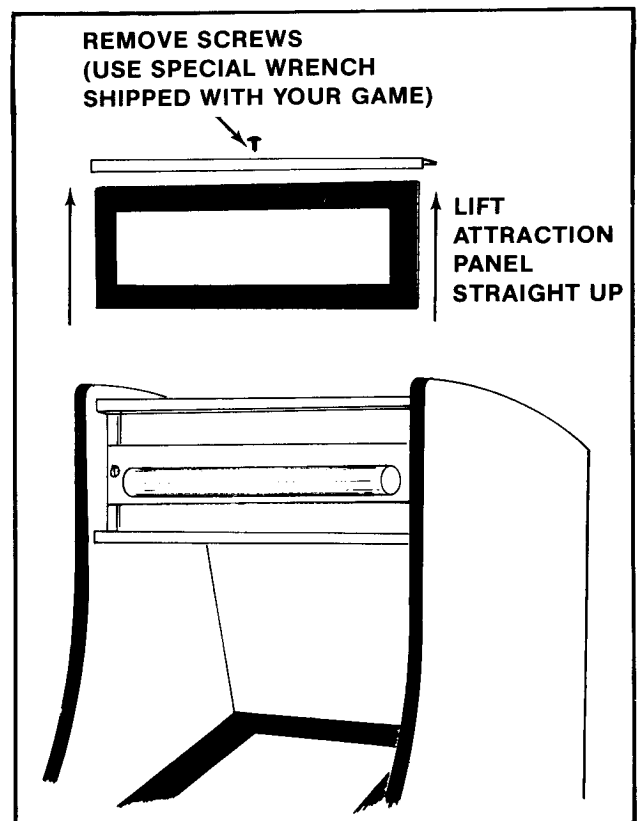

Figure 20 Removing attraction panel — Upright game

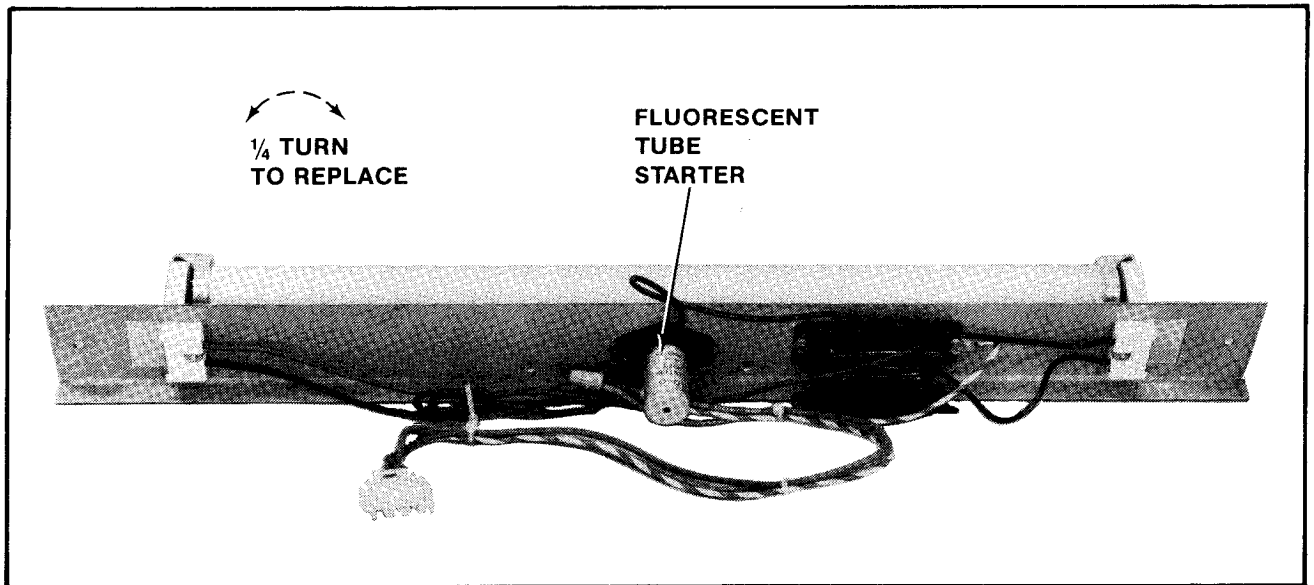

Figure 21 Replacing fluorescent starter — Upright game

2. MINI MODEL: See Figure 23.

- **Turn the power off to the game.**
- Remove the screws from the top and bottom of the formed attraction panel.
- Remove the formed attraction panel by pulling it straight away from the cabinet. This exposes the attraction panel light bulbs and their mounting board.
- To service the light bulbs and their mounting board:
Turn the power to the game back on so you can see which bulbs are burnt out.
Mark the burnt out bulbs and **turn the power to the game back off again.**

To replace the burnt out bulbs, grasp them gently and pull straight out.

The new bulbs are gently pushed into the empty sockets.

To completely replace the light bulb mounting board:

Open the cabinet rear access door and unplug the mounting board from its power cable.

Remove the screws that hold the mounting board to the cabinet.

Gently slide the mounting board out the front of the cabinet being careful not to catch its cable on anything.

To reinstall the above removed items, reverse this procedure.

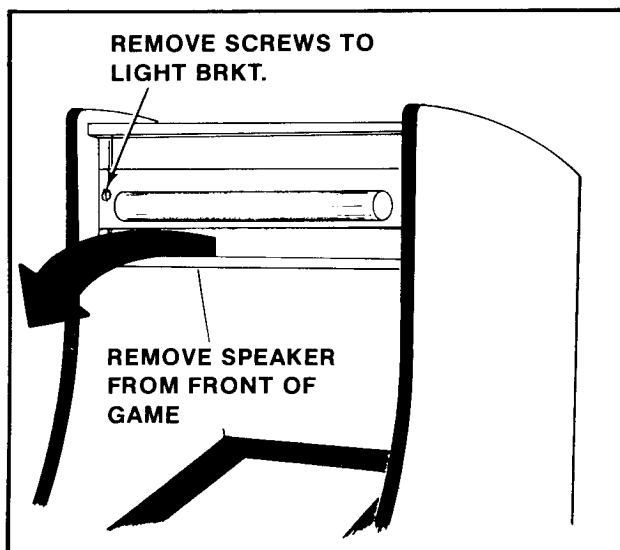

Figure 22 Replacing fluorescent light mounting bracket & speaker — Upright game

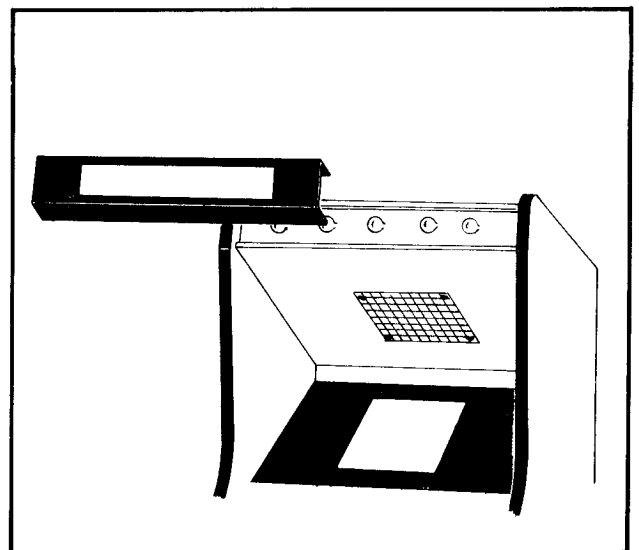

Figure 23 Removing attraction panel — Mini game

- To replace the speaker. See Figure 24.
Be sure the power is off to the game.
 Disconnect the speaker from its cabling.
 Remove the nuts and bolts securing the speaker.
 Slide the speaker out through the rear access door.
 To reinstall the speaker, simply reverse this procedure.

3. THE COCKTAIL TABLE MODEL HAS NO BACK-LIT ATTRACTION PANEL.

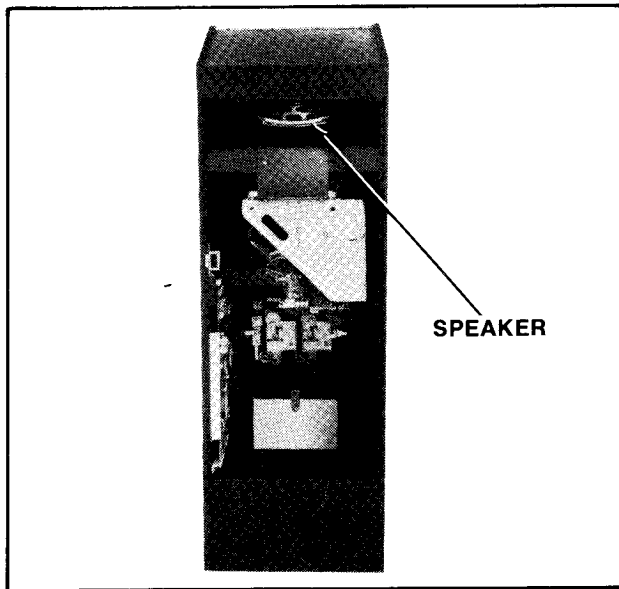

Figure 24 Replacing speaker — Mini game

COIN DOOR MAINTENANCE

METAL COIN ACCEPTOR MECHANISMS

Periodically, the metal coin acceptor mechanism(s) must be removed from the coin door and cleaned.

- 1. Make sure the power to the game is off.**
- Unlock and open the coin door.
- Remove the coin acceptor mechanism as shown in Figure 25.
 - Push down on the two spring loaded latches.
 - While holding the latches down, pull the top of the coin acceptor mechanism toward you.
 - Release the latches and lift out the coin acceptor mechanism.
- Clean the magnet of all foreign particles. See Figure 26.
 - This may be accomplished by swinging the gate open as shown in the above figure.
- Remove the cradles and undersize levers and clean the bushings. (A pipe cleaner makes a good bushing cleaner.)
 - Also clean the pivot pin.
- Whenever needed, the coin acceptor should be cleaned with hot water and cleanser in the following manner:
 - Place the coin acceptor in boiling water for about ten minutes.

CAUTION: BE CAREFUL NOT TO BURN YOURSELF.

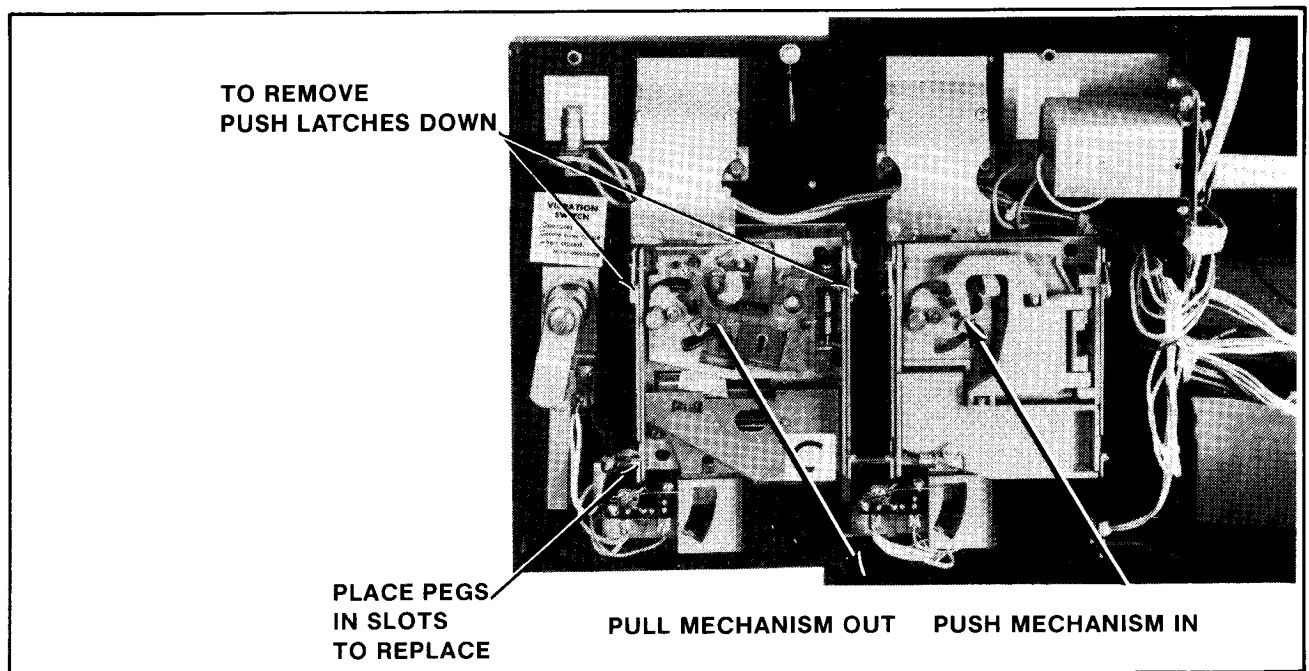

Figure 25 Removing and replacing coin acceptor

- Next, use a brush and kitchen cleaner to remove all remaining foreign matter from the unit.
- Rinse the coin acceptor in clean boiling water.
- Dry the coin acceptor thoroughly by using filtered compressed air to blow it dry.

NOTE: The reason we recommend using boiling water is that it evaporates faster than cold water and speeds drying time.

7. To lubricate the coin acceptor:

- Use **ONLY** powdered graphite and put it **ONLY** on the moving parts of the coin acceptor. These parts are called out in Figure 27.
- Be extremely careful to keep the powdered graphite away from paths that are traveled by the coins.

**WARNING:
DO NOT USE OIL
TO LUBRICATE THE
COIN ACCEPTOR.**

8. Check the coin chute for obstructions such as: paper, gum, etc.
9. Reinstall the coin acceptor to the coin door. See Figure 25.
- Place the two pegs at the coin acceptor's base into their retaining slots.

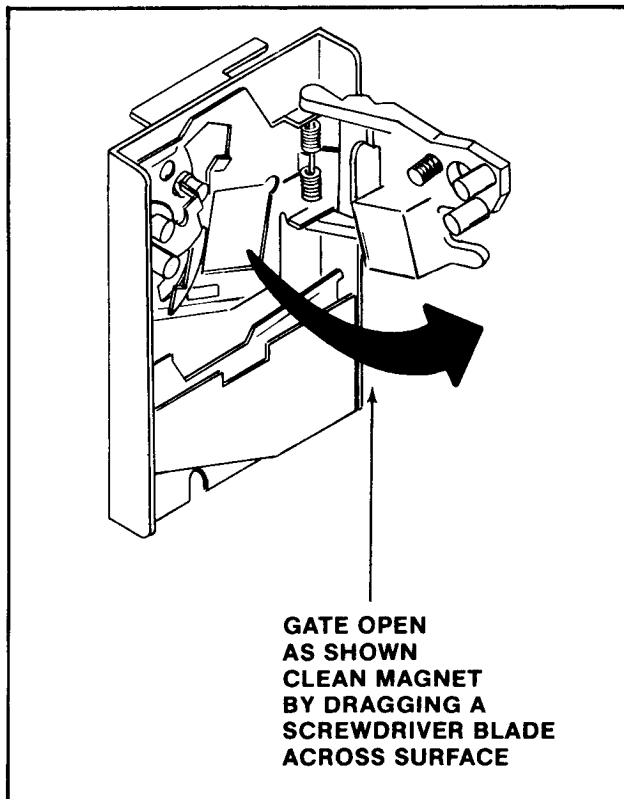

Figure 26 Cleaning the metal coin acceptor

- Now push the top of the coin acceptor toward the coin door until it snaps in place and is held there by the two spring loaded latches.
10. Close and lock the coin door.

PLASTIC COIN ACCEPTOR MECHANISMS

The plastic coin acceptor mechanism(s) must be removed periodically from the coin door and cleaned.

1. **Make sure the power to the game is off.**
2. Unlock and open the coin door.
3. Remove the coin acceptor mechanism(s) as shown in Figure 25.
 - Push down on the two spring loaded latches.
 - While holding the latches down, pull the top of the acceptor mechanism toward you.
 - Release the latches and lift out the mechanism.
4. Squeeze the two pins indicated in Figure 28 together to open the mechanism and break it down into its three basic parts.
 - Clean the mechanism in hot soapy water. It never rusts.
 - Rinse the mechanism in clean hot water and allow it to dry.
 - Reassemble the mechanism (it never needs lubrication).

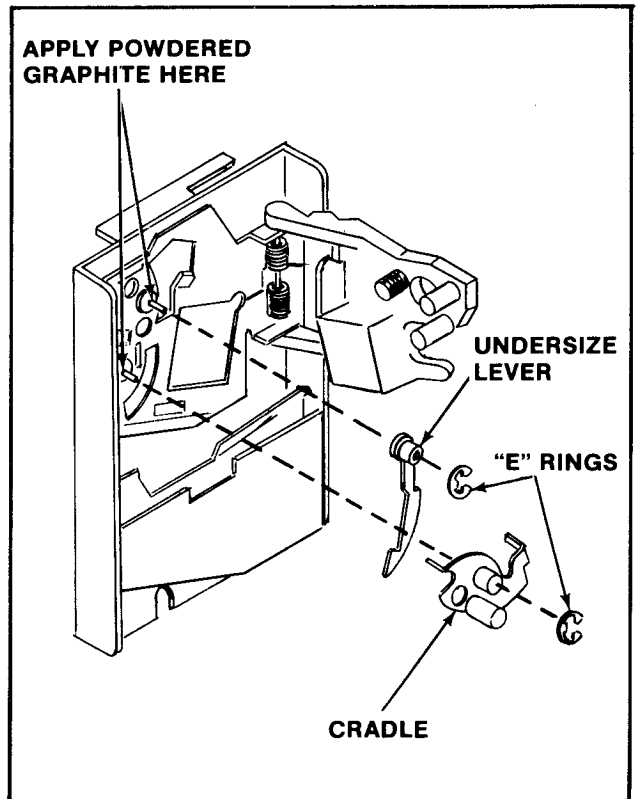

Figure 27 Lubricating the metal coin acceptor

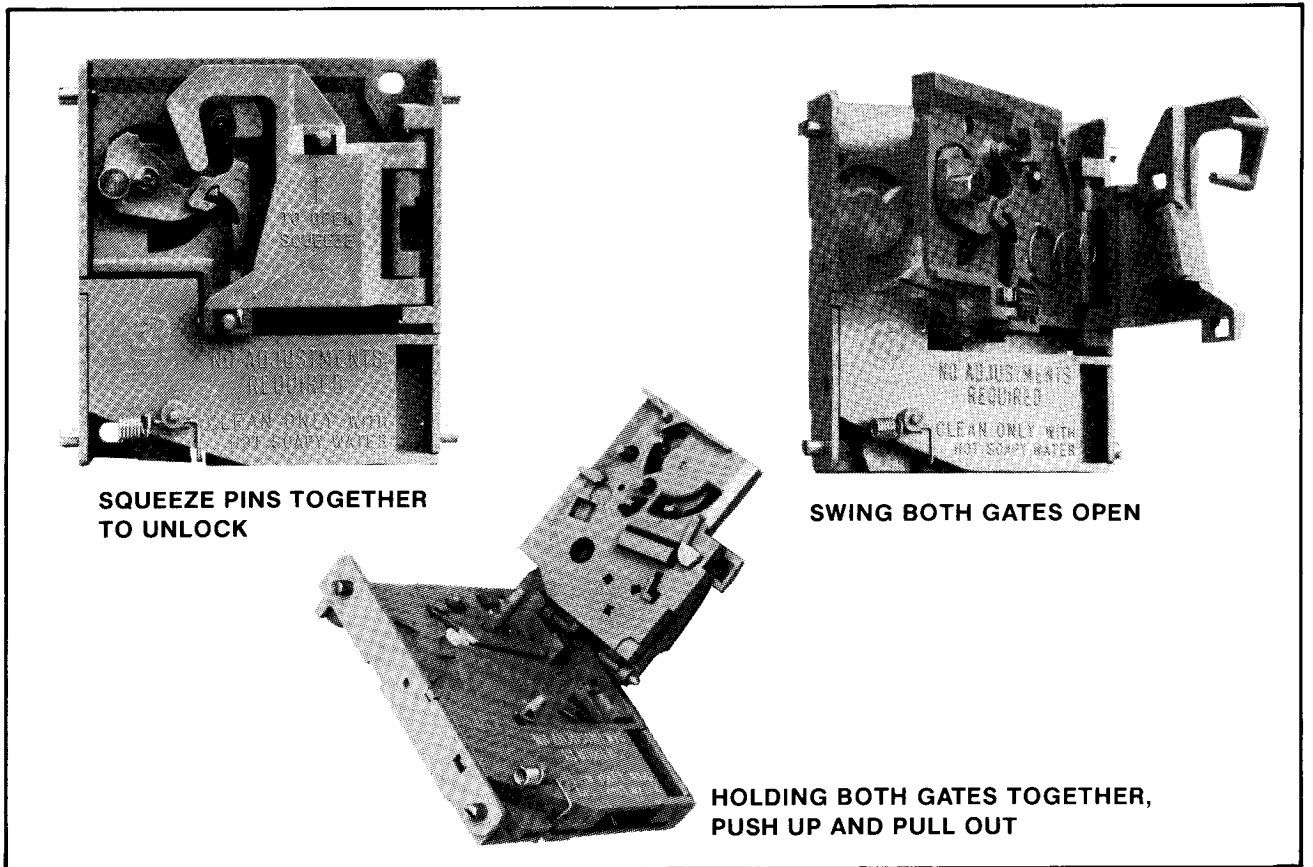

Figure 28 Opening the plastic coin acceptor

5. Check the coin chute for obstructions such as paper, gum, etc.
6. Reinstall the coin acceptor to the coin door. See Figure 25.
 - Place the two pegs at the coin acceptor's base into their retaining slots.
 - Now push the top of the coin acceptor toward the coin door until it snaps in place and is held there by the two spring loaded latches.

7. Close and lock the coin door.

NOTE: See Figure 29 for instructions on how to set the plastic coin acceptor mechanisms to either accept or reject Canadian quarters.

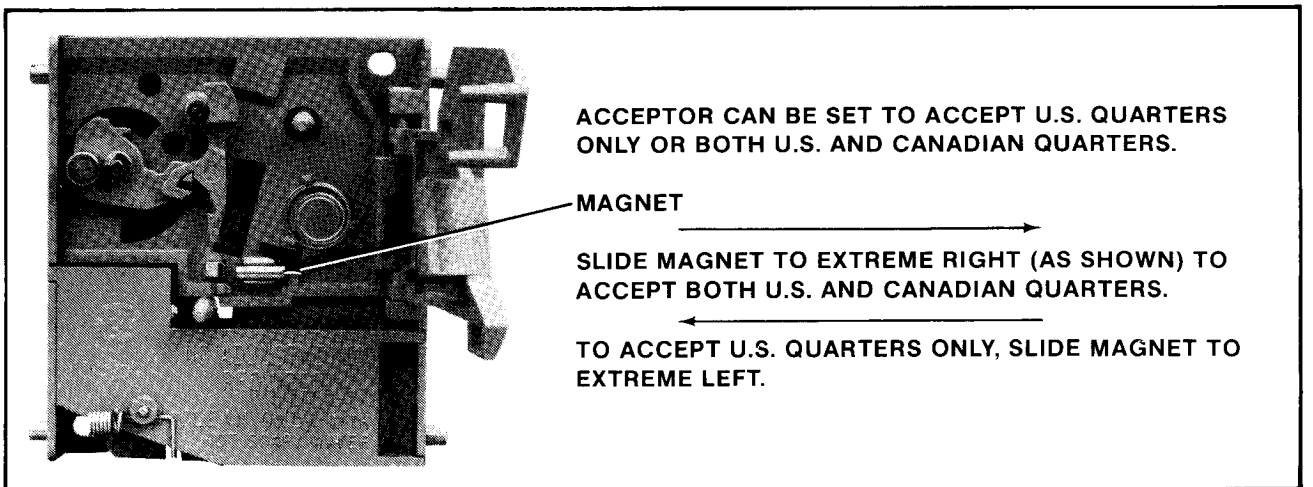

Figure 29 Changing the plastic coin acceptor to accept American or Canadian quarters

LEVEL OF DIFFICULTY MODIFICATION

In order to increase the level of difficulty with which your MS. PAC-MAN game plays, a jumper wire must be installed as described below.

NOTE: Installing this jumper wire will definitely make your MS. PAC-MAN game **CONSIDERABLY more difficult to play**. However, if you desire a more difficult game (say, one for **ADVANCED** players), the jumper wire may be installed as follows:

1. Remove the Main Game Logic Board as described elsewhere in this manual.
2. Remove the coating of green insulatory material over the two halves of the jumper pad shown in

Figure 30. **BE CAREFUL NOT TO DAMAGE THE FOIL OF THE JUMPER PAD IN ANY WAY.**

3. Solder in a jumper wire connecting the two halves of the pad.

NOTE: If you are not sure if you'll want to leave the jumper wire connected or not, you may wish to install a small toggle or slide switch in your jumper wire and secure it to the cable harness to keep it from shorting out any components on the Main Game Logic Board.

4. When finished, reinstall the Main Game Logic Board as described elsewhere in this manual.

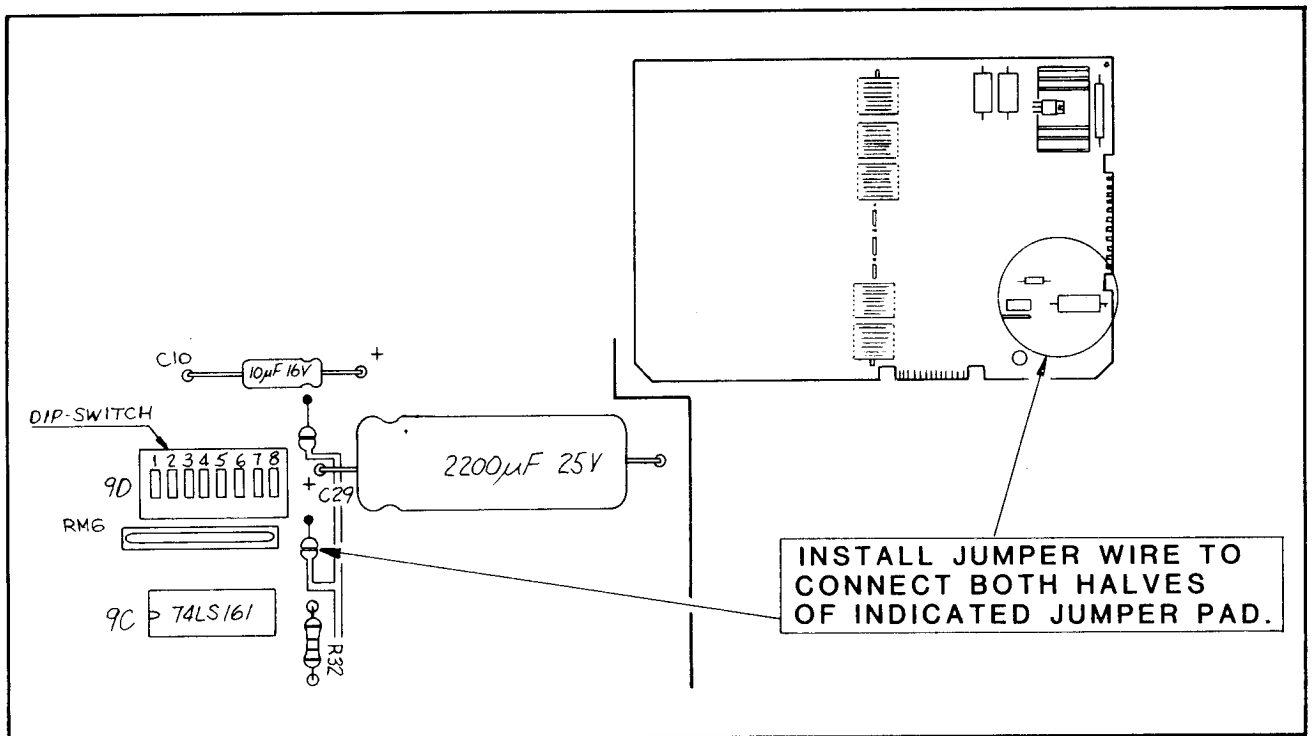
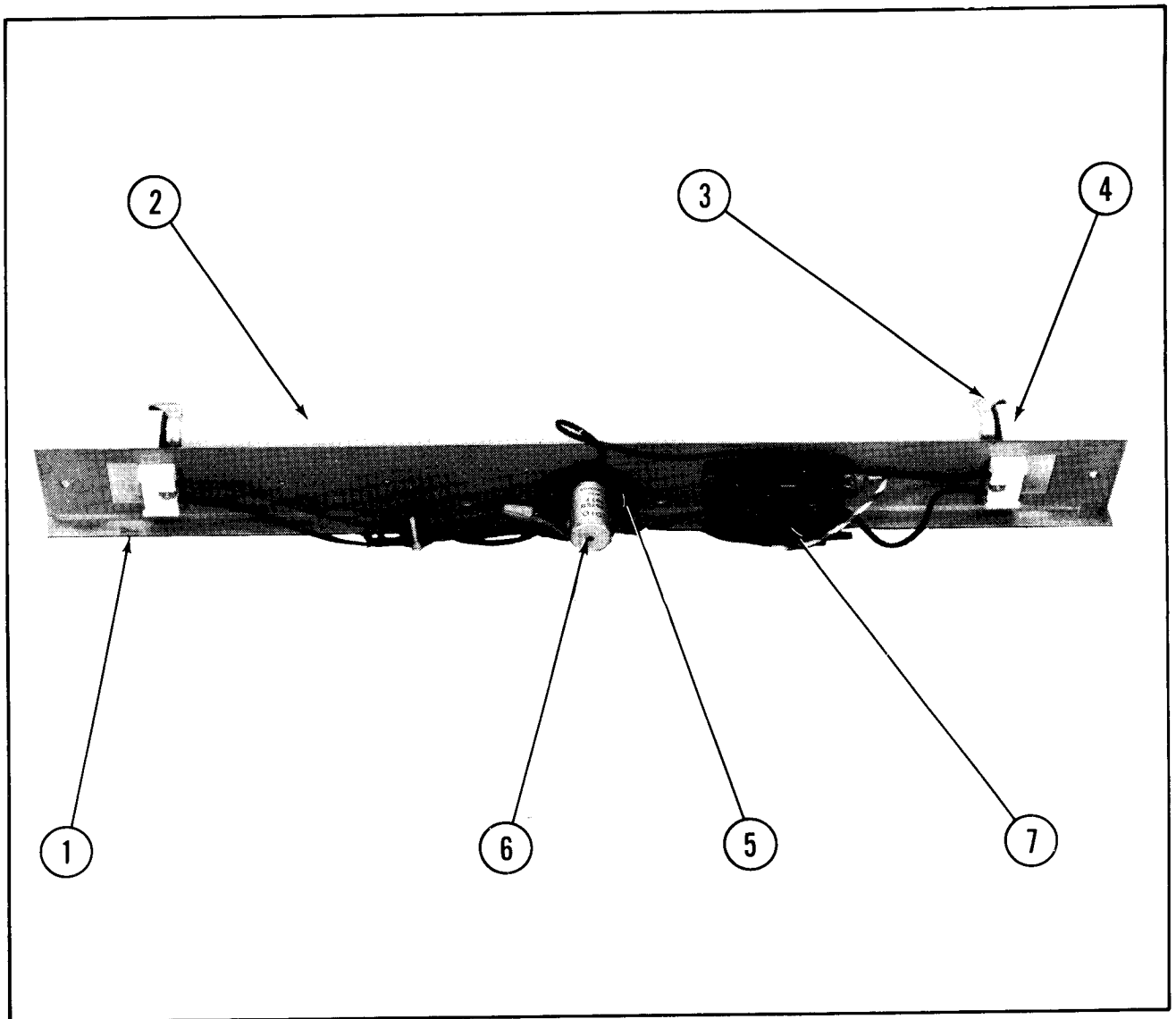

Figure 30 Changing difficulty level of game

IV Illustrated Parts Breakdown

NO. 595 — MS. PAC-MAN — UPRIGHT — HEADER FLUORESCENT LIGHT ASSY.



NO. 595 — MS. PAC-MAN — UPRIGHT — HEADER FLUORESCENT LIGHT ASSY. — PARTS LIST

ORDER BY PART NUMBER ONLY

ITEM	PART NO.	DESCRIPTION
1	0595-00105-0000	FLUORESCENT BRKT.
2	0017-00003-0043	18" COOL WHITE FLUOR. LAMP
3	0017-00021-0005	FLUORESCENT LOCKS (2 REQ'D.)
4	0017-00031-0036	FLUORESCENT SOCKET (2 REQ'D.)
5	0017-00003-0412	FLUOR. STARTER HOLDER W/LEADS
	0017-00101-0573	#6-32 x 1/2 PHIL. RND. HD. M.S. (4 REQ'D.)
	0017-00104-0009	#6 EXT. WASHER (4 REQ'D.)
6	0017-00003-0019	FLUOR. STARTER
7	0017-00003-0026	BALLAST
	0017-00101-0598	#8-32 x 5/16 SLT. HEX HD. SCR. (4 REQ'D.)
	A961-00042-0000	LINE FILTER ASSY. — NOT SHOWN

NO. 595 — MS. PAC-MAN — UPRIGHT — FRONT

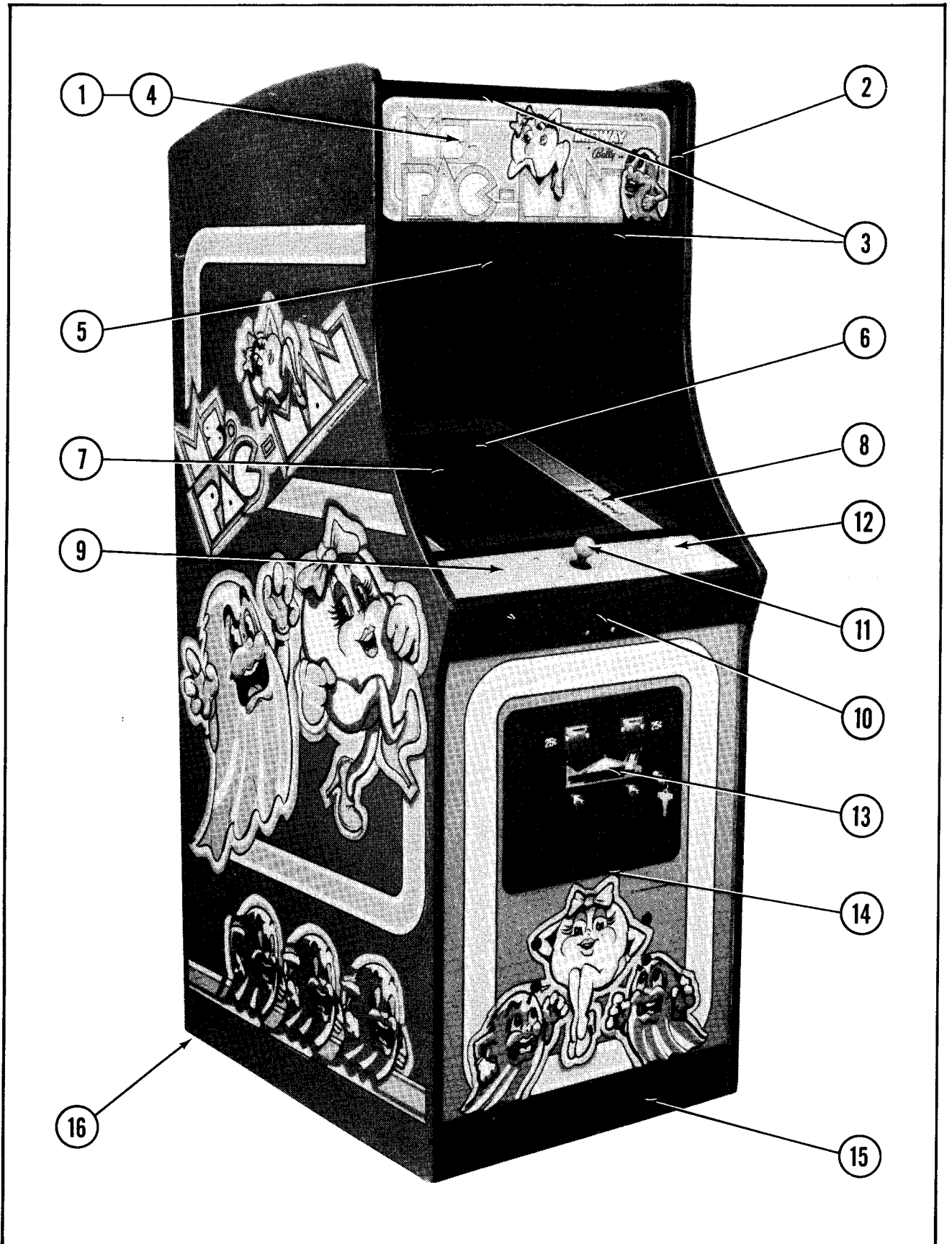

NO. 595 — MS. PAC-MAN — UPRIGHT — FRONT — PARTS LIST

ORDER BY PART NUMBER ONLY

ITEM	PART NO.	DESCRIPTION
1	0595-00901-00XF	DECORATIVE HEADER PLEXI — 23" x 9-1/16" x 3/16"
2	0537-00903-0057	GLASS CHANNEL — 7-5/8" LG. (2 REQ'D.)
3	0508-00104-00XF	UPPER/LOWER HEADER RETAINER (2 REQ'D.)
	0017-00101-0138	#8 x 5/8 TORX TAMPER RESISTANT SCR. (6 REQ'D.)
	0017-00009-0522	LONG ARM KEY T-20 (FOR ABOVE SCREW)
4	A595-00011-0000	FLUORESCENT HEADER ASSY.
5	0017-00009-0393	BLACK SPEAKER GRILLE W/SLOTS
	0017-00003-0259	6" x 9" SPEAKER 8 OHM, 7W.
	0017-00101-0127	#8-32 x 1-1/2 CARRIAGE BOLT (4 REQ'D.)
	0017-00103-0061	#8-32 HEX NUT W/SEMS (4 REQ'D.)
6	0508-00900-0000	19" C.R.T. BEZEL
7	0508-00905-0000	T.V. PLEXI-GLASS (SMOKED) — 17-3/8" x 13-1/4" x 1/8"
	0508-00901-0000	PLEXI-GLASS CLIPS (4 REQ'D.)
	0017-00101-0017	#6 x 1/2 SLT. HEX HD. BLK. SCR. (4 REQ'D.)
8	0595-00900-00XF	MAIN VIEWING GLASS — 23" x 21-1/8" x 3/16"
	0508-00108-0000	GLASS STOP BRKT.
	0017-00101-0027	#8 x 3/4 SLT. HEX HD. M.S. (3 REQ'D.)
9	0595-00903-0000	CONTROL SHELF DECORATIVE OVERLAY
10	A595-00007-00XF	CONTROL SHELF PLATE W/STRIKE ASSY.
	0017-00101-0620	#8-32 x 1/2 CARRIAGE BOLT (10 REQ'D.)
	0017-00103-0061	#8-32 HEX NUT W/SEMS (10 REQ'D.)
	0017-00101-0341	#6 x 1/4 PHIL. TRS. HD. SCR. (4 REQ'D.)
	0508-00115-0000	CENTER CONTROL SHELF LOCK BRKT.
	0961-00115-00XF	STRIKE (2 REQ'D.)
	0017-00009-0033	LATCH CLAMP (3 REQ'D.)
	0595-00106-0100	CONTROL SHELF MTG. BRKT. — RIGHT
	0595-00106-0200	CONTROL SHELF MTG. BRKT. — LEFT
	0555-00901-0000	LOCATING PIN (PLASTIC) (4 REQ'D.)
	0017-00101-0141	#8 x 11/16 UNSLOT. HEX HD. M.S. (14 REQ'D.)
	A595-00017-0000	CONTROL SHELF CABLE ASSY.
11	A595-00005-0000	CONTROL ASSY.
12	0017-00042-0260	PUSH BUTTON ASSY. — WHITE (2 REQ'D.)
	0017-00032-0093	PUSH BUTTON SWITCH W/HOLDER (2 REQ'D.)
	0017-00103-0054	5/8-11 PAL NUT (2 REQ'D.)
13	A090-00300-07BK	U.S.A. COIN DOOR ASSY. — 25¢
14	0090-00002-04BK	LARGE COIN DOOR FRAME
	0017-00101-0121	#6-32 x 5/16 PHIL. TRS. HD. SCR. (3 REQ'D.)
	A595-00019-0000	COIN DOOR CABLE ASSY.
15	0935-00906-0100	KICK PLATE — 23" LG.
16	0017-00102-0048	3/8-16 x 2" LEG LEVELERS (4 REQ'D.)
	0017-00103-0026	3/8-16 LEG LEVELER HEX NUTS (4 REQ'D.)