

STREET FIGHTER II™

©1990 CAPCOM ALL RIGHTS RESERVED

CAPCOM U.S.A.

KIT INSTRUCTION MANUAL

WARNING

THIS GAME MUST BE GROUNDED. FAILURE TO DO SO MAY RESULT IN DESTRUCTION TO ELECTRONIC COMPONENTS.

WARNING: This equipment generates, uses and can radiate radio frequency energy and if not used in accordance with the instruction manual, may cause interference to radio communications. It has been tested and found to comply with the limits for a CLASS A computing device pursuant to SUBPART J and PART 15 of FCC RULES, which are designed to provide reasonable protection against such interference when operated in a commercial environment. Operation of this equipment in a residential area is likely to cause interference in which case the user at his own expense will be required to take whatever measures may be required to correct the interference.



“WINNERS DON’T USE DRUGS”

William S. Sessions, Director, FBI

IN COOPERATION WITH THE AAMA AND FBI ANTI-DRUG CAMPAIGN

CAPCOM, USA INC.

INVITES YOU TO USE

***OUR SERVICE NUMBER FOR
SERVICE INFORMATION CONCERNING THIS GAME, OR ANY
OTHER CAPCOM GAME YOU NOW HAVE ON LOCATION.
PLEASE HAVE GAME SERIAL NUMBERS AND CABINET NUMBERS READY.***

***CALL US FOR PROMPT, COURTEOUS
ANSWERS TO YOUR PROBLEMS.***

Direct Number

(408) 727-0400

Before You Get Started...Stop!

1. Does your **new game** package include all listed parts? (Is it complete?)
2. Is the game you have chosen to transform able to supply all the required voltages for the **new game**?

Note: Some games, (i.e. Ms. Pac Man, Galaxian, etc.) regulate their voltages on the main P.C.B. This makes the existing power supply inefficient. These games will require a change in power supply for your **new game**. Many game supply houses can offer you a switching regulated power supply for a relatively low cost.

3. Is the monitor configuration compatible? In most games it is rather difficult to change the monitor from a vertical mount to a horizontal mount. We recommend you choose a game cabinet with the same mount as your **new game** requires.
4. Do you have the necessary tools? (See the recommended tool list)
5. Are you using a FCC approval power supply? **VERY IMPORTANT.** (Most games do not comply because of their power supply).

WARRANTY, REPAIR AND RETURN POLICY

REPLACEMENT PARTS:

CAPCOM USA maintains a stock of replacement parts for our products. When placing an order for parts, please supply a complete description of the item, quantity required, P.O. number and shipping information. We attempt to ship items the day they are received, orders received after 12:00 noon will ship the following work day. We do have a minimum order requirement at this time, and we certainly appreciate your efforts to consolidate your orders whenever possible.

Payments Terms are NET 30.

RETURN MATERIAL AUTHORIZATIONS:

Material can be returned to CAPCOM only in the following situations:

1. Parts, return for credit. A parts order was processed incorrectly, ie; wrong items were shipped, wrong quantity was shipped, etc.
2. PCB, return for credit. A PCB is being returned for credit to satisfy an Advantage Exchange transaction.
3. Other, parts are being returned for engineering analysis, etc, only with prior consent of Customer Service or Sales Department.

To obtain a Return Material Authorization, please contact CAPCOM Customer Service Department. Describe the transaction and request an RMA number. The outside of the package must be clearly marked with the RMA number. Packages not displaying an RMA number will be returned un-opened.

WARRANTY REPAIRS:

During the initial 60-day warranty, customers whose accounts are current are eligible for an Advance Exchange PCB. When calling for an Advance Exchange PCB, please supply a complete description of the item needed, number for warranty verification, P.O. number and shipping information. You will be issued an RMA number for the return of the defective PCB.

LIMITED WARRANTY

CAPCOM warrants only to the initial purchaser of its products that the items listed below are free from defects in material and workmanship under normal use and service for the warranty periods specified:

- | | | |
|----------------------------|-----------|---------------|
| A. Printed Circuits Boards | (60) Days | (C.P.S. Chip) |
| B. Electronic Components | (30) Days | |
| C. Television Monitors | (30) Days | |

No other parts of products are warrantied.

Warranty periods are effective from the initial date of shipment from CAPCOM to it's authorized distributors.

This warranty does not apply to any parts damaged during shipping or handling, or due to improper installation or usage or alteration. In no event shall CAPCOM be liable for any anticipated profits, loss of profits, loss of use, incidental or consequential damages or any other losses incurred by the customer in connection with the purchase of CAPCOM products.

Terms for Advance Exchanges are NET 15. If the defective PCB is not returned within 30 days, no additional Advance Exchanges will be issued until the offending PCB is returned or the invoice is paid in full. If the PCB is not returned until after 90 days, the warranty will be voided and the customer will be liable for all repair charges. Each transaction not more than one set PCB.

It is our goal to constantly improve and better our services to you. Your Cooperation with the above stated policies will help us greatly to reach this goal. If you have any comments or questions, please telephone our Customer Service Department. We will make every attempt to tailor our services accordingly.

*Each customer cannot withhold Advance Exchange more than two set PCB at the same time and same ite/

Installing Your New



©1990 CAPCOM ALL RIGHTS RESERVED

New Game Package

Table of Contents

Power and Monitor Requirements	2
New Game Package Contents	2
Recommended Tools and Supplies	3
Dip Switch Tables	4
Installation Procedures	5
Helpful Hints	11
Control Panel Positioning/Main Harness Connections	12
Warranty Registration Card	15



©1990 CAPCOM ALL RIGHTS RESERVED

POWER REQUIREMENTS		MONITOR REQUIREMENTS
FCC Approved power supply		Horizontal Mount Raster Scan Negative Composite Sync
+5 VDC	7 amp	
+12 VDC	1 amp	

NEW GAME PACKAGE CONTENTS

1 Main Printed Circuit Board (PCB)	1 Control Panel Overlay
1 Set Legs, Bolts, & Spacers	1 Plex Control Cover
1 Connecting Wire Harness	1 Set Side Graphics
2 Eight-Way Joysticks	1 Monitor Card
14 Player Button Assemblies	1 Service and Installation Manual
1 Marquee	

Note: Replacement accessories available through your exclusive **Capcom** distributor

Recommended Tools and Supplies

CAPCOM new game package.

Phillips and Slot Screwdrivers
Socket Set
Wire Cutters and Strippers
Pliers or Channel Locks
Planning and Careful Thought
Electric Drill
 $\frac{3}{32}$ " , $\frac{1}{4}$ " , $\frac{7}{16}$ " Drill Bits
 $\frac{1}{4}$ " Plex Bit
 $1\frac{3}{16}$ " Chassis or Sheet Metal Punch
 $1\frac{1}{4}$ " Plex Hole Saw
Glass of Water and a Snack
Small File
Razor Knife and Sharp Blades
Straight Edge

Painting Supplies
(if you do your own painting)
Paint Brush and Paint
(don't forget the primer)
Paint Roller and Pan
Sand Paper
Putty Knife and Wood Putty
Staple Gun and Staples
Soldering Iron and 60/40 **Resin Core** Solder
Vacuum Cleaner
Assorted Fastening Hardware
Shrink Tubing: $\frac{3}{32}$ " , $\frac{1}{8}$ " , $\frac{3}{16}$ "
Masking Tape
 $3\frac{1}{2}$ " OR 4" Wire Ties
Spray Window Cleaner and Rags
(baby diapers work GREAT!)

Dip Switch Tables

Optimize Your Profits

Thorough Research shows that two and a half minute games both satisfy players and also keep the quarters flowing.

If games aren't running about two and a half minutes long, then collections probably aren't at their peak. You'll want to tailor your game to your location. The trick is to adjust a few DIP switches. (See the chart in this book.) It's easy!

DIP SW (A)

ITEM	DESCRIPTION	1	2	3	4	5	6	7	8
COIN 1	1 COIN 1 CREDIT	OFF	OFF	OFF					
	1 COIN 2 CREDITS	ON	OFF	OFF					
	1 COIN 3 CREDITS	OFF	ON	OFF					
	1 COIN 4 CREDITS	ON	ON	OFF					
	1 COIN 6 CREDITS	OFF	OFF	ON					
	2 COINS 1 CREDIT	ON	OFF	ON					
	3 COINS 1 CREDIT	OFF	ON	ON					
4 COINS 1 CREDIT	ON	ON	ON						
COIN 2	1 COIN 1 CREDIT				OFF	OFF	OFF		
	1 COIN 2 CREDITS				ON	OFF	OFF		
	1 COIN 3 CREDITS				OFF	ON	OFF		
	1 COIN 4 CREDITS				ON	ON	OFF		
	1 COIN 6 CREDITS				OFF	OFF	ON		
	2 COINS 1 CREDIT				ON	OFF	ON		
	3 COINS 1 CREDIT				OFF	ON	ON		
4 COINS 1 CREDIT				ON	ON	ON			
CONTINUE COIN	NORMAL							OFF	
	CONTINUE COIN							ON	
NO USE									OFF ON

* WHEN CONTINUE IS ON, GAME STARTS WITH 2 COINS AND CONTINUES WITH 1 COIN. IN THIS CASE, SETTINGS OF COIN 1 AND COIN 2 ARE MEANINGLESS.

* BOLDFACE INDICATES FACTORY SETTING.

DIP SW (B)

ITEM	DESCRIPTION	1	2	3	4	5	6	7	8
DIFFICULTY	EASY 0	OFF	OFF	OFF					
	↑	ON	OFF	OFF					
	2	OFF	ON	OFF					
	NORMAL 3	ON	ON	OFF					
	↓	OFF	OFF	ON					
	4	ON	OFF	ON					
	5	OFF	ON	ON					
	6	OFF	ON	ON					
DIFFICULT 7	ON	ON	ON						

* DIFFICULTY LEVEL IS SET TO NORMAL AT THE TIME OF DELIVERY.

* BOLDFACE INDICATES FACTORY SETTING.

DIP SW (C)

ITEM	DESCRIPTION	1	2	3	4	5	6	7	8
FREE PLAY	NOT FREE PLAY			OFF					
	FREE PLAY			ON					
SCREEN STOP	NORMAL				OFF				
	PAUSE				ON				
SCREEN FLIP	NORMAL					OFF			
	FLIP					ON			
SOUND DURING DEMONSTRATION MODE	OFF						OFF		
	ON						ON		
CONTINUE MODE	OFF							OFF	
	ON							ON	
TEST MODE	GAME MODE								OFF
	TEST MODE								ON

* BOLDFACE INDICATES FACTORY SETTING.

* POWER DOWN AFTER CHANGING DIP SWITCHES.

* MAKE SURE THE POWER IS OFF BEFORE CHANGING DIP SWITCHES.

Installation Procedures

Something to Think About

Your final product will be a **new game**.

You have made a wise decision to transform a game that has seen better days in the all important cash box into a **new game**. This is by far the most cost effective alternative to maximize the return of your initial investment. All you provide is the cabinet with a power supply and a monitor. Oh yes, you will need a touch of elbow grease. And that's it! We provide the rest. The end result is . . . a **new game** at a very low cost.

Fact: Spend a little time on the cabinet's appearance (i.e. marquee, control panel, and cabinet graphics). With a little paint, some wood putty and new lights, you will raise the profits of any game . . . especially with the introduction of a **new game** package.

The **new game** look should always apply to the inside of your game as well as the outside. A few wire ties and shrink tubing on your harness; some fastening hardware on your subassemblies and a sweep with the ol' vacuum cleaner will ensure that unnecessary *glitches* do not occur.

Remember: You are creating a **new game**.

If you have any questions or just need some advice on any of your **new game** transformations, don't hesitate in giving a member of our technical staff a call.

Let's Get Our Hands Dirty

Preparing the Original Game for the New Game

Remove the following:

1. Main Logic Board(s)
2. Control Panel
3. Monitor Plexiglas
4. Monitor Bezel
5. Marquee
6. Graphics

I would recommend painting your cabinet to give it a fresh new look. (If it is geographically inconvenient to make use of our facilities, you may consider having an auto body shop take care of your painting needs.)

If your cabinet has wood grain sides; remove old graphics and adhesive (adhesive may be removed with **lacquer** thinner).

If you intend to use your original Plexiglas, be sure it is in mint condition or it should be replaced.

Thoroughly clean out your cabinet.

Time to Install Your New Goodies

Before You Start . . . Remember DO NOT Do this Work with the Power On!

Logic P.C.B. Cage

Mount the logic cage securely (away from power supply).

- A Mark and drill pilot holes ($3/32''$).
- B Place the logic cage (bottom) over the holes and secure it with the supplied wood screws.
- C Install the P.C.B. into the logic cage. Use feet and spacers supplied and adjust them so that the screws will go through the slots in the cage bottom.

Note: Leave the cage cover off until you have attached the entire wire harness and have tested the game for proper operation.

Wire Harness

Attach the wire harness connector to the main logic board. **CAUTION:** Sometimes the connector is not keyed and it is very easy to install it reversed on the logic board. Even if it is keyed, always **triple check** to be sure the wire inputs were connected correctly to the connector and the connector to the logic board.

Connecting the Wire Harness to the Existing Wires

When you hook up the control panel, power supply, monitor or other subassemblies that remain in the game cabinet to your new wire harness, try and use their existing secondary connectors.

1. Cut the original wire approximately three inches from the original connector. Strip off about one half inch of insulation.
2. Solder the new wire designated for that position to the original wire you just stripped.

Warning: DO NOT JUST TIE THE WIRES TOGETHER. THIS CAN CAUSE NAGGING INTERMITTENT PROBLEMS THROUGH LOOSE CONNECTIONS OR OXIDATION OR BOTH. **Always take the time to do it right.**

3. Melt shrink tubing around all your in-line wire connections. Do not use electrical tape. Tape could unravel over a period of time due to the cabinet heat and cause you a great deal of trouble.
4. Use wire tie wraps, and secure the cable to the cabinet whenever it seems necessary. Remember this is a **new game**, not a sloppy conversion.

Power Wires

1. Connect the wires that are designated for your power supply. You will need a supply of +5V, +12V & ground. Your **new game** package may not require all of the voltages that were used in the original game. Tie off any unused wires.
2. You will notice that you probably have more than one wire for each voltage. It is a good idea to use all wires supplied (double up if it is necessary). This will help to ensure that you don't overload the edge connector pins and cause them to "burn".

Monitor Wires

You will be connecting the wires designated for the RED, GREEN & BLUE video guns along with the SYNC & GROUND wires.

NOTE: . . . CONCERNING SYNC:

Your **new game** only calls for one sync wire connection, this is called **composite sync** (horizontal and vertical tied together). This composite sync is also **negative**. Most monitors have supply positions for both negative and positive sync. You can check your monitor manual or call our technical department for assistance.

Speaker Wires

Find the two wires that are designated for the speaker and hook 'em on up.

Coin Door Wires

1. Connect the designated wires to the coin switches and meter.
2. You can connect your door lamps to the unused -5V power supply. Some games have separate power outputs for the coin door lamps.
3. Be sure to clean and lubricate your old coin mechanisms. Keep the money coming in.

Guess What?

You are almost done with the electrical connections of your **new game**. All you have left is the control panel wiring. But we are going to hold off on that for right now. We have a few other things we need to do first. So why don't you go ahead and get yourself a drink of water and stretch your legs. When you return, we can take a fresh look at your progress and then move forward.

Smoke Test

What Test?

Don't worry. All this means is that you are ready to apply power to the system for the first time and you pray that there will be no smoke from a simple oversight.

You are just about ready to power up the logic board. But first we need to recheck your work.

1. Carefully inspect the game for loose power wires, exposed connections and extra fastening hardware.
2. Make sure the logic board, board cage, monitor, and power supply are securely fastened in place.
3. **Double check** the connectors to be sure they are wired and connected properly.
4. Set the dip switches on the logic board to the factory recommendations.

Time to Apply Power:

1. Look and smell for smoke. (TURN OFF IMMEDIATELY IF ANY IS NOTICED)
2. Listen for game sounds.

If after one minute you have not heard any sounds:

- A) Check for proper dip switch settings.
- B) Adjust volume control and check speaker connections.
- C) Check the +12V power supply to the logic board.

NOTE: If you do get sounds, but they are a little fuzzy, switch the wires around on the speaker. See page 12 for more helpful hints.

3. How is the monitor image?

A) Is the picture in sync?

If your picture has the top and bottom halves of the screen reversed and it will not stop rolling, change your sync polarity on the monitor. (Positive to negative).

If your monitor does not have dual polarity positions for sync, then you will need to reverse the sync yourself by installing a simple one I.C. circuit between the logic board and the monitor. (The following illustration shows a hookup for both **composite** and **separate** syncs.

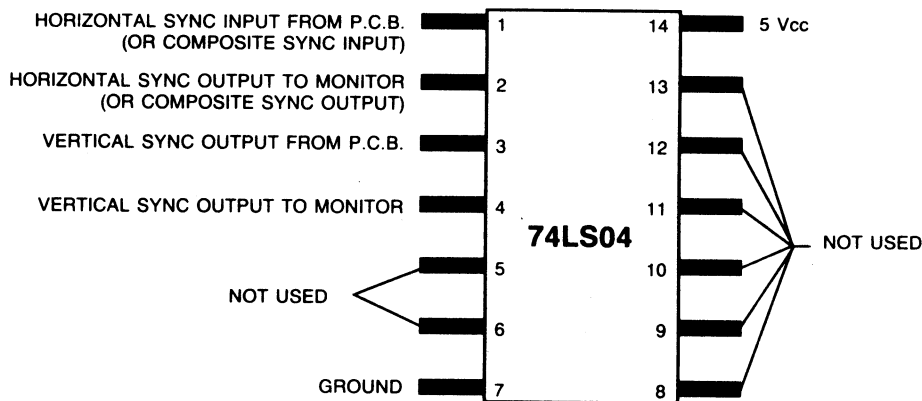

G07 MONITOR SYNC MODE

1. Replace R314 from 390Ω to 1.8KΩ resistor
2. Replace C303 from .1μf 35V cap, locate "+" side of cap to collector of X305
3. Replace C501 with .1μf (old C303)

B) Now how's your picture?

- Is it centered?
- Is it too bright or dim?
- Is it in focus?

Check your monitor manual for these adjustments. If your screen looks "off", then your **new game** transformation may have been in vain. So let's take the time to make the monitor look great.

C) Is the picture upside-down?

Dip switch 5 on switch bank "C" should solve your problems.

Control Panel Assembly

1. Remove the buttons, joysticks and wire harness and put them aside for now. Do not remove the original panel overlay until the new holes have been drilled.
2. Mark positions on the panel for the new holes.
CAPCOM supplies a clear 1/8" thick of Plexiglas with every **new game** package to convert the control panel. We feel that your **new game** investment is well worth protecting . . . and the control panel is the first place to show wear and tear.
 - You will need to cut this piece to size. Use the control panel as a template.
 - Use a razor knife to score the Plexiglas **deeply**. Then use a pair of pliers to break away the extra Plexiglas.
3. Now drill the holes in your panel that you have marked off for the *buttons*, *joystick* and *bolts*.
4. Drill the same holes on your Plexiglas panel protector. Once again use your panel as a template.
Hint: To avoid chipping while you are drilling the holes, place the Plexiglas securely on a soft wood surface and use a Plexiglas drill bit and hole cutter.
5. The holes are now all cut. Smooth them out on your panel and Plexiglas with a fine toothed file.
6. Remove the original graphics overlay from the panel. Clean up the panel and install your **CAPCOM** graphics.
Make It Easier: Peel the top half of the protective backing off of your graphics. Start from the center and smooth out your overlay. Make sure you have about an inch extra coming off the top. *No bubbles please*. Now peel off the bottom half and do the same as you did for the top.
7. Adhere the instruction and function labels.
8. Install the Plex Control Cover over your completed **new game** panel.
Note: Be sure to bolt the Plexiglas securely to the panel.
9. Mount the joystick and the buttons to the panel and wire them up. (Use the existing Panel wiring if possible)

Marquee Installation

Using the original marquee as a template, Center your **new game** marquee graphics and score the new marquee deeply to fit the cabinet. Break off the excess with pliers.

Be sure the light behind the marquee works. Everything should **always work** on a new game.

Take your time . . . Don't forget this is going to be a **new game**.

Side Graphic Installation

1. Be sure sides of game are clean and free of old adhesive, dust, etc.
2. Mark position of decal with erasable pen or pencil (centered on upper half of cabinet).
3. Peel off top ¼" of decal backing and apply to cabinet with a smoothing motion (use a soft rag). Continue peeling off backing and smoothing.
4. Remove any small bubbles with a pin or razor blade (pop them!)

Finishing Touches

1. Check the game inside and out for any imperfections. Secure any loose wiring or fastening hardware.
2. Make sure the coin door is tight and the coin mechs are well adjusted. A game is no good to anybody if you can't get a coin into it.
3. Once again go over every step of this **new game** transformation in your mind. Be sure everything is correct and to your liking.
4. Power up the game.
 - A. Check all the coin switches. (Does the coin meter work?)
 - B. Play your **new game**.
 - Are all the player controls working?
 - Are the game sounds present?
 - Is the volume level proper?
 - Is the test switch set up properly?

Well, that's about it. Good Luck.

HELPFUL HINTS IN CASE OF DIFFICULTY

PROBLEM/CAUSE-CURE

No Raster/No Video

- Check A.C. line cord
- Check line fuse
- Check monitor brightness
- Check power switch and/or interlock switch
- Check all solder connections on line filter and transformer
- Check for proper orientation of the PCB connector

Raster/No Video

- Check all PCB to monitor connections
- Check power supply voltage on PCB

No Video/Game sounds can be heard

- Check monitor brightness
- Check all PCB to monitor connections

Wrong Colors

- Monitor needs degaussing
- Check for proper wiring between PCB and monitor
- Check monitor adjustment and adjust if necessary

Wavy Picture

- Check monitor ground is properly connected to monitor
- Be certain sync inputs are properly connected to monitor
- Check horizontal hold adjustment

Horizontal/Vertical Roll

- Check horizontal and/or vertical hold adjustments
- Check for proper wiring of sync from PCB to monitor

No Sound

- Check for -5 volts on edge connector of PCB
- Check volume control potentiometer adjustment
- Check for +12 volts on edge connector of PCB
- Check wiring from PCB to speaker
- Check speaker for low resistance between the "+" and "-" tabs

Bad Sound

- Check wiring to speaker for bad solder connections
- Check sound with another speaker

No Switch Input

- Check ground connection to switch/es
- Check wiring between PCB and switch/es for proper connection
- Check switch/es with an ohmmeter to verify proper operation

Switch Operates Incorrect Function

- Check wiring between PCB and switches for proper orientation
- Check wiring for shorts between switch inputs

No Coin Meter

- Check wiring to coin meter
- Check that +5 volts is on "+" side of meter
- Verify a +5 volt meter is used

When coin switch is made and meter pulses, the screen blanks out and/or game resets

- Verify that a meter with a diode is used
- If no diode is built in meter, a IN4004 can be used across the meter.
Cathode to "+" side of meter and anode to "-" side of meter

Also see CAUTIONS under section "Before You Get Started"

CONTROL PANEL POSITIONS

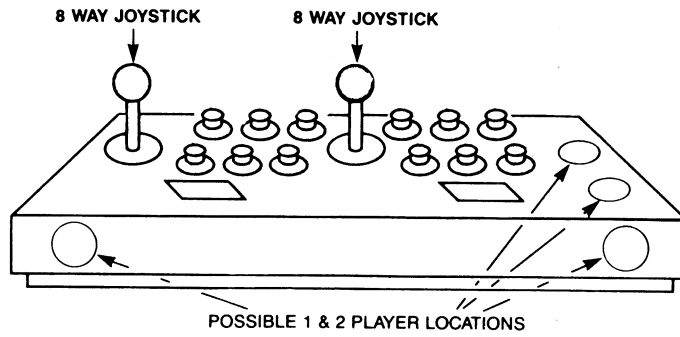

- PCB CONNECTOR

JAMMA STANDARD

- CRT MONITOR

HORIZONTAL SCREEN

- CONTROL PANEL

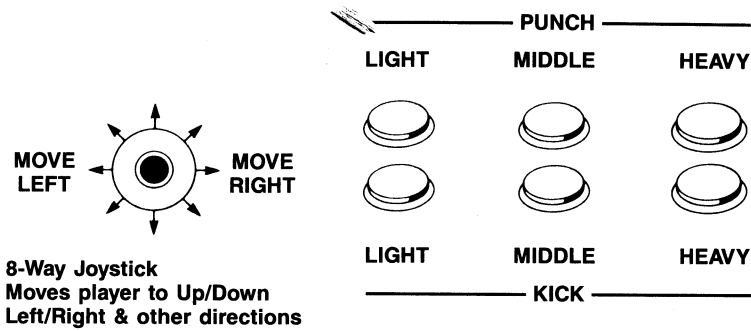

2-PLAYER SIMULTANEOUS

- MAXIMUM CREDITS: 9
- POSITIONS OF DIP SW (There are 2 types of PCB)

1.

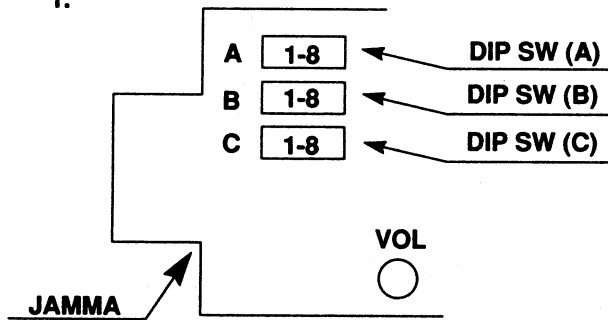

2.

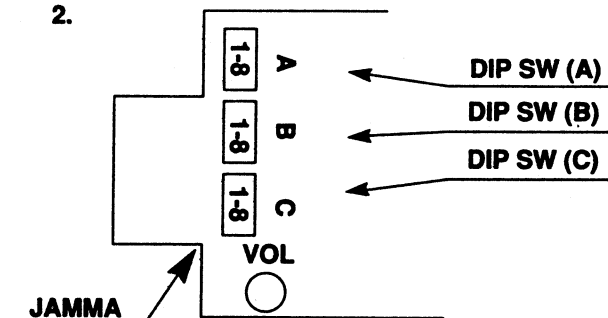

HOW TO CONNECT THE ATTACHED HARNESS LINES

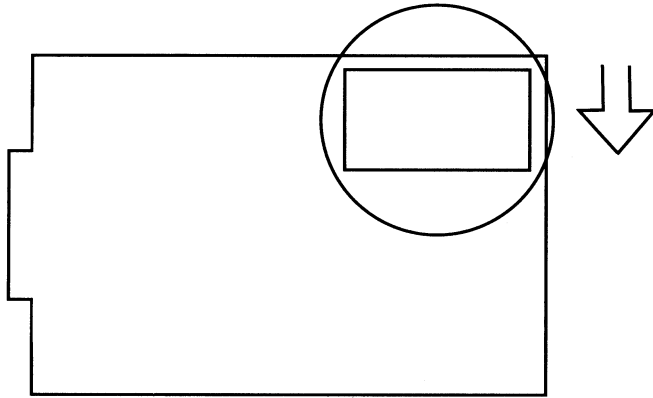

CNI 02

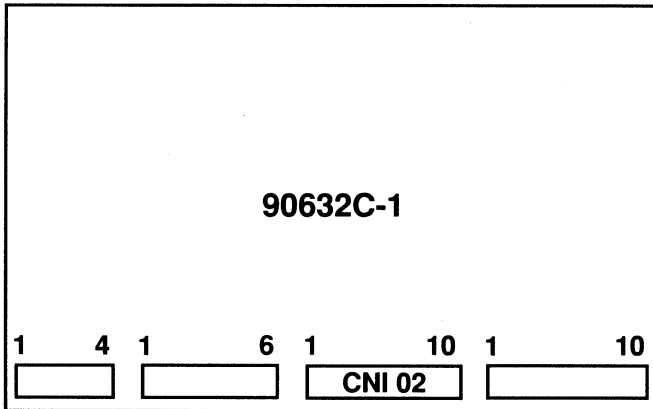

90632C-1

1 4 1 6 1 10 1 10
 CNI 02

10 PIN

GND	1	BLACK
GND	2	BLACK
1P KICK LIGHT	3	PURPLE
1P KICK MIDDLE	4	GRAY
1P KICK HEAVY	5	WHITE
N.C.	6	
2P KICK LIGHT	7	ORANGE
2P KICK MIDDLE	8	GREEN
2P KICK HEAVY	9	BLUE
N.C.	10	

JAMMA STANDARD

SOLDER SIDE			COMPONENTS SIDE
GND	A	1	GND
GND	B	2	GND
+5V	C	3	+5V
+5V	D	4	+5V
N.C.	E	5	N.C.
+12V	F	6	+12V
	H	7	
COIN COUNTER 2	J	8	COIN COUNTER 1
(COIN LOCK OUT 2)	K	9	(COIN LOCK OUT 1)
SP (-)	L	10	SP (+)
N.C.	M	11	N.C.
VIDEO GREEN	N	12	VIDEO RED
VIDEO SYNC	P	13	VIDEO BLUE
SERVICE SW	R	14	VIDEO GND
N.C.	S	15	TEST SW
COIN SW 2	T	16	COIN SW 1
START SW 2	U	17	START SW 1
2P UP	V	18	1P UP
2P DOWN	W	19	1P DOWN
2P LEFT	X	20	1P LEFT
2P RIGHT	Y	21	1P RIGHT
2P PUSH 1	Z	22	1P PUSH 1
2P PUSH 2	a	23	1P PUSH 2
2P PUSH 3	b	24	1P PUSH 3
N.C.	c	25	N.C.
N.C.	d	26	N.C.
GND	e	27	GND
GND	f	28	GND

• PARTS NAME

CR7E-56DA-3.96E: (HIROSE)

OR

1168-056-009 :(KEL)

CAPCOM GAME OWNER:

Please fill out card and register for Free drawing at COIN-OP SHOWS.
YOU NEED NOT BE PRESENT TO WIN.

Remember to fill in S/N of PCB (S/N IS REQUIRED FOR DRAWING).

REGISTER FOR FREE DRAWING



-15-



FROM:

PLACE
STAMP
HERE

CAPCOM U.S.A., INC.

3303 Scott Boulevard
Santa Clara, CA 95054



3303 Scott Boulevard
Santa Clara, CA 95054
(408) 727-0400

COMPANY NAME

[Grid for company name]

LAST NAME

FIRST NAME

[Grid for last and first name]

ADDRESS

[Grid for address]

CITY

STATE

ZIP CODE

AREA CODE / PHONE NO.

[Grid for city, state, zip, and phone number]

PRODUCT PURCHASED:

DATE OF PURCHASE

PURCHASED FROM:

MONTH DAY YEAR

[Grid for purchase details]

S/N

[Grid for serial number]

HOW WOULD YOU RATE THIS GAME:

EXCELLENT VERY GOOD FAIR POOR

AAMA NO.

[Grid for AAMA number]

HOW DID YOU HEAR ABOUT THIS GAME:

MAGAZINE FRIEND OTHER _____

DO YOU OWN ANY OTHER CAPCOM ARCADE GAMES?

YES NO PLAN TO BUY IN NEAR FUTURE

WHAT TYPE OF ROUTE DO YOU OWN:

ARCADE SMALL ROUTE LARGE ROUTE HOW MANY GAMES DO YOU OWN _____

WHAT CAPCOM ARCADE GAMES ARE YOU FAMILIAR WITH: CAPCOM BOWLING GHOULS'N'GHOSTS STRIDER FORGOTTEN WORLDS

BUSTER BROS. FINAL FIGHT MERCYS UN SQUADRON 1943 STREET FIGHTER WILLOW _____

COMMENTS:

[Grid for comments]