

TROUBLESHOOTING GUIDE

**Complete with Signatures
and Memory Map**

Tempest™ Troubleshooting Guide

Complete with Signatures and Memory Map

Copyright © 1981 by Atari, Inc. All rights reserved.

No part of this publication may be reproduced by any mechanical, photographic, or electronic process, or in the form of a phonographic recording, nor may it be stored in a retrieval system, transmitted, or otherwise copied for public or private use, without permission from the publisher.

The Tempest™ game play, all graphic designs, this troubleshooting guide, the technical manual, its accompanying schematic diagrams, and the monitor manual are protected by the new Copyright Act of 1976.

This Act provides for increased penalties for violating federal copyright laws. Courts *can impound* infringing articles while legal action is pending. If infringers are convicted, courts can *order destruction* of the infringing articles.

In addition, the Act provides for payment of statutory damages of up to \$50,000 in certain cases. Infringers may also have to pay costs and attorneys' fees, fines up to \$25,000, and face an imprisonment of up to one year.

Atari will aggressively enforce its copyrights against any infringers. *We will use all legal means* to immediately halt any manufacture, distribution or operation of a copy of video games made by us. Anyone who purchases such copies risks forfeiting such a game.

Published by:
ATARI INC.
1265 Borregas Avenue
P. O. Box 427
Sunnyvale, California 94086

Reproduced in the U.S.A. **10K**

Table of Contents

1	Memory Map	1
2	Watchdog	2
3	Troubleshooting Using the CAT Box	2
	A. CAT Box Preliminary Set-up	2
	B. Address and Data Lines	2
	C. RAM	3
	D. Option Switch Inputs	3
	E. Custom Audio I/O Chips	4
	F. Player Input Switches and Encoder Wheel	5
	G. LED and Coin Counter Outputs	5
4	Troubleshooting with Signature Analysis	6
	A. Signature Analysis Set-up	6
	B. Address Lines	7
	C. Address Decoder	7
	D. ROM and Data Lines	8
	E. Math Box	11

List of Illustrations

Figure 1	Memory Map	1
Figure 2	Address and Data Lines	3
Figure 3	Custom Audio I/O Chips	4
Figure 4	Led and Coin Counter Addresses	5
Figure 5	Analog Vector-Generator Data	6
Figure 6	S.A. Harness Assembly	11
Figure 7	S.A. Harness Assembly	13

NOTE

If reading through this manual does not lead to solving a certain maintenance problem, call Tele-Help® at the Atari Customer Service office in your geographical area, as shown below.

WEST and CENTRAL U.S.A.

Parts for all Atari customers in the U.S.A. Game sales and service

Atari, Inc.
California Customer Service Office
1105 N. Fair Oaks Avenue
P. O. Box 427, Sunnyvale, CA 94086
Telex 17-1103
(Monday–Friday, 7:30–4:00 pm Pacific Time)

☎ From California, Alaska or Hawaii
(408) 745-2900

☎ From anywhere else in this area
toll-free (800) 538-1611

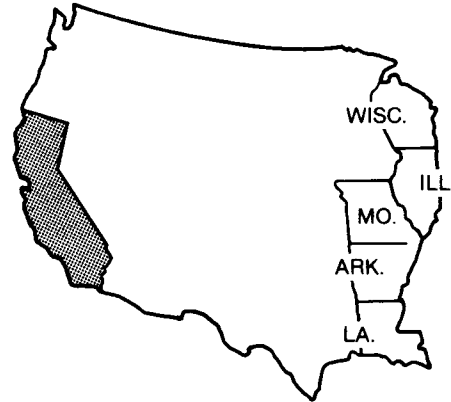

EAST U.S.A.

Game sales and service only

Atari, Inc.
New Jersey Customer Service Office
12A World's Fair Drive, Somerset, NJ 08873
Telex 37-9347
(Monday–Friday, 7:30–4:00 pm Eastern time)

☎ From New Jersey
(201) 469-5993

☎ From anywhere else in this area
toll-free (800) 526-3849



EUROPE

Parts for all Atari customers in Western Europe.

Game sales and service

Atari Ireland Limited
European Customer Service Office
Tipperary Town, Ireland
Telex 28165
(Monday-Friday, 9:00-6:00 pm GMT)

☎ 062-52155

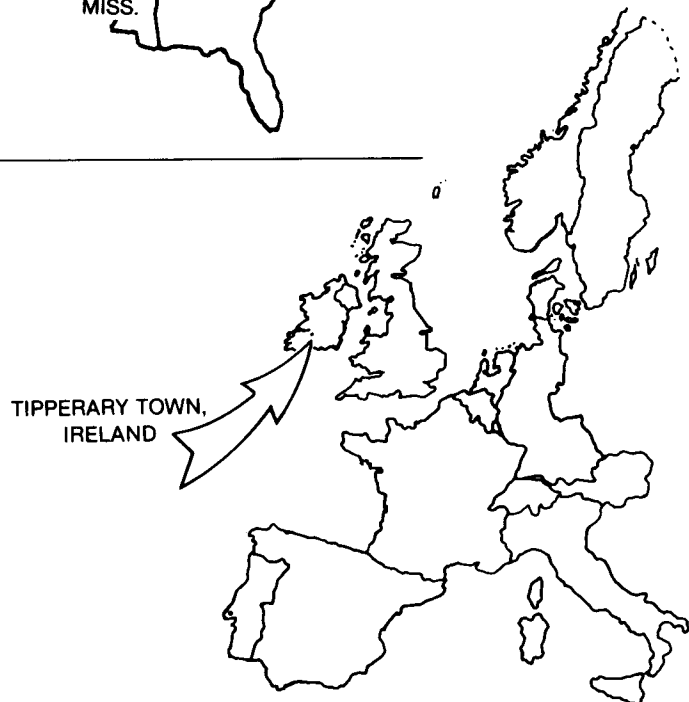

1 Memory Map

MEMORY MAP										
HEXA-DECIMAL ADDRESS	R/W	DATA								FUNCTION
		D7	D6	D5	D4	D3	D2	D1	D0	
0000-7FFF 0800-080F	R/W W	D	D	D	D	D	D	D	D	Program RAM (2K) Color RAM
0C00	R								D	Right Coin Switch
0C00	R							D		Center Coin Switch
0C00	R						D			Left Coin Switch
0C00	R					D				Slam Switch
0C00	R				D					Self-Test Switch
0C00	R			D						Diag.Step Switch
0C00	R	D								HALT
0C00	R	D								3KHz
0D00	R	D	D	D	D	D	D	D	D	Option Switch Inputs
0E00	R	D	D	D	D	D	D	D	D	Option Switch Inputs
2000-2FFF 3000-3FFF	R/W R	D	D	D	D	D	D	D	D	Vector RAM (4K) Vector ROM (4K)
4000	W								D	Right Coin Counter
4000	W							D		Center Coin Counter
4000	W					D				Video Invert X
4000	W				D					Video Invert Y
4800	W									VG GO
5000	W									WD CLEAR
5800	W									VG Reset
6000-603F	W	D	D	D	D	D	D	D	D	EAROM Write
6040	W	D	D	D	D	D	D	D	D	EAROM Control
6040	R	D								Math Box Status
6050	R	D	D	D	D	D	D	D	D	EAROM Read
6060	R	D	D	D	D	D	D	D	D	Math Box Read
6070	R	D	D	D	D	D	D	D	D	Math Box Read
6080-609F	W	D	D	D	D	D	D	D	D	Math Box Start
60C0-60CF	R/W	D	D	D	D	D	D	D	D	Custom Audio Chip 1
60D0-60DF	R/W	D	D	D	D	D	D	D	D	Custom Audio Chip 2
60E0	R								D	One Player Start
60E0	R							D		Two Player Start
60E0	R					D				FLIP
9000-DFFF	R	D	D	D	D	D	D	D	D	Program ROM (20K)

Figure 1 Memory Map

2 Watchdog

The Watchdog circuit will cause continuous reset pulses to the microprocessor if a problem exists within the microprocessor circuit. If the self-test fails to run, it is a good practice to check the reset line.

RESET—microprocessor input (pin 40). In a properly operating game, reset should occur during power-up or when the reset push button is activated. A pulsing reset line indicates that something is causing the microprocessor to lose its place within its program. Typical causes are:

1. Open or shorted address or data bus lines
2. Bad microprocessor chip
3. Bad bus buffers
4. Bad ROM
5. Bad RAM
6. Any bad input or output that causes an address or data line to be held in a constant high or low state

A pulsing RESET signal indicates a problem exists somewhere within the microprocessor circuitry rather than within either the Math Box or the Analog Vector Generator.

3 Troubleshooting

Using the CAT Box

A. CAT Box Preliminary Set-up

1. Remove:

- The electrical power from the game.
- The wiring harnesses from the game PCBs.
- The main and auxiliary boards from the game cabinet.
- The microprocessor chip C2 from the main PCB.

2. Connect:

- The harnesses from the game to the main and auxiliary boards. (Use extender cables if available.)
- $\phi 0$ and $\phi 2$ test points together.
- W DOG DIS test point to ground.
- The CAT Box flex cable to the main PCB test edge connector.

3. Power Up:

- The game.
- The CAT Box.

4. Set CAT Box Switches:

- TESTER SELF-TEST: (OFF)
- TESTER MODE: R/W
- Press TESTER RESET

B. Address and Data Lines

NOTE: This section assumes that IC F2 is a 74LS245.

1. Perform the CAT Box preliminary set-up.
2. Connect the DATA PROBE to the CAT Box and the game ground test point.
3. TESTER MODE: R/W

4. BYTES: 1.
5. PULSE MODE: UNLATCHED
6. R/W MODE: (OFF)
7. R/W to WRITE
8. Key in address pattern on the keyboard (*use AAAA to start*)
9. Push DATA SET
10. Key in data pattern on the key board (*use AA to start*)
11. R/W MODE: STATIC
12. Probe the IC-pin with the data probe and check for the 1 or 0 LED as indicated in Figure 2. Repeat this step for each address and data line.
13. Repeat steps 6-11 using 5555 in step 8 and 55 in step 10.

Figure 2 Address and Data Lines

When writing AAAA pattern Logic State	Address and data lines IC-Pin	When writing 5555 pattern Logic State
1	B3-1	0
0	B3-3	1
1	B3-2	0
0	A/B-3	1
1	A/B-18	0
0	A/B-16	1
1	A/B-14	0
0	A/B-12	1
1	B/C-3	0
0	B/C-5	1
1	B/C-7	0
0	B/C-9	1
1	B/C-18	0
0	B/C-16	1
1	B/C-14	0
0	B/C-12	1
1	F2-9	0
0	F2-8	1
1	F2-7	0
0	F2-6	1
1	F2-5	0
0	F2-4	1
1	F2-3	0
0	F2-2	1

C. RAM

1. Perform the CAT Box preliminary set-up.

2. Set the CAT Box switches as follows:
 - a. Press TESTER RESET
 - b. DBUS SOURCE: ADDR
 - c. BYTES: 1024
 - d. R/W MODE: (OFF)
 - e. R/W: WRITE
 - f. Enter 0000 on the keypad
 - g. Toggle R/W MODE to PULSE and back to (OFF)
 - h. R/W: READ
 - i. Toggle R/W MODE to PULSE and back to (OFF)
3. If the CAT Box reads an address that doesn't compare, the COMPARE ERROR LED lights up, the ADDRESS/SIGNATURE display shows the failing address location, and the ERROR DATA DISPLAY switch is enabled. Using this switch, determine if the error is in the high- or low-order RAM.
4. Repeat the test with DBUS SOURCE set to ADDR.
5. Repeat steps 2-4, entering 0400 on the keypad (step f).
6. Repeat steps 2-4, entering 2000 on the keypad (step f).
7. Repeat steps 2-4, entering 2400 on the keypad (step f).
8. Repeat steps 2-4, entering 2800 on the keypad (step f).
9. Repeat steps 2-4, entering 2C00 on the keypad (step f).

D. Option Switch Inputs

1. Perform the CAT Box preliminary set-up.
2. BYTES: 1
3. R/W: READ
4. R/W MODE: (OFF)
5. Key in 0D00
6. R/W MODE: STATIC
7. Activate the option switches at location N13 while monitoring the DATA DISPLAY. The DATA DISPLAY will change if the switches are operating properly.
8. Repeat steps 4-7, entering 0E00 in step 5, and activate switches at location L12.

E. Custom Audio I/O Chips

NOTE: Tempest™ has two custom audio I/O chips. Each must be tested separately. There are several ways to test the chips:

- Perform the Self-Test.
- Substitute good part for defective part.
- Use the procedure that follows.

1. Perform the CAT Box preliminary set-up.
2. BYTES: 1
3. R/W: WRITE
4. R/W MODE: (OFF)
5. Enter address from Figure 3
6. Press DATA SET
7. Enter the data from Figure 3
8. R/W MODE to PULSE and back to (OFF)
9. Repeat steps 5-8 for each address and data, noting the test results.



Figure 3 Custom Audio I/O Chips

ADDRESS	DATA	TEST RESULTS
60CF	00	Custom Audio I/O Chip #1 channel 1 produces pure tone.
60CF	03	
60C0	55	
60C1	AF	
60C1	00	Custom Audio I/O Chip #1 channel 1 off.
60C2	55	Custom Audio I/O Chip #1 channel 2 produces pure tone.
60C3	AF	
60C3	00	Custom Audio I/O Chip #1 channel 2 off.
60C4	55	Custom Audio I/O Chip #1 channel 3 produces pure tone.
60C5	AF	
60C5	00	Custom Audio I/O Chip #1 channel 3 off.
60C6	55	Custom Audio I/O Chip #1 channel 4 produces pure tone.
60C7	AF	
60C7	00	Custom Audio I/O Chip #1 channel 4 off.

ADDRESS	DATA	TEST RESULTS
60DF	00	Custom Audio I/O Chip #2 channel 1 produces pure tone.
60DF	03	
60D0	55	
60D1	AF	
60D1	00	Custom Audio I/O Chip #2 channel 1 off.
60D2	55	Custom Audio I/O Chip #2 channel 2 produces pure tone.
60D3	AF	
60D3	00	Custom Audio I/O Chip #2 channel 2 off.
60D4	55	Custom Audio I/O Chip #2 channel 3 produces pure tone.
60D5	AF	
60D5	00	Custom Audio I/O Chip #2 channel 3 off.
60D6	55	Custom Audio I/O Chip #2 channel 4 produces pure tone.
60D7	AF	
60D7	00	Custom Audio I/O Chip #2 channel 4 off.

F. Player Input Switches and Encoder Wheel

1. Perform the CAT Box Preliminary Set-up
2. DBUS SOURCE to DATA
3. BYTES: 256
4. R/W: WRITE
5. R/W MODE: (OFF)
6. Key in 60D0
7. Press DATA SET
8. Key in 00
9. Toggle R/W MODE to PULSE and back to (OFF)
10. BYTES: 1
11. R/W: READ
12. Key in 60D8
13. R/W MODE: STATIC
14. Pushing the following player input switches should cause the DATA DISPLAY to change: FIRE, SUPERZAPPER, 1-player start and 2-player start. (Also Player-2 FIRE and Player-2 SUPERZAPPER in cocktail* games.)

NOTE: For the encoder wheel, repeat the above instructions keying in 60C0 in step 6 and 60C8 in step 12. Turning the encoder wheel should cause the DATA DISPLAY to change.

*To test player-2 inputs in cocktail games connect IC D6-1 to + 5.

G. LED and Coin Counter Outputs

1. Perform the CAT Box Preliminary set-up.
2. DBUS SOURCE to DATA
3. BYTES: 1
4. R/W: WRITE
5. R/W MODE: (OFF)
6. Key in address from Figure 4
7. Press DATA SET
8. Key in on or off data from Figure 4
9. R/W MODE to STATIC and back to (OFF)
10. Repeat steps 6-9 to turn off coin counter solenoids, or to test another address.

If you write data that activates a solenoid, deactivate it by pressing the reset button on the game board or by writing "off" data. If you leave a solenoid activated for more than about 10 seconds it will overheat and may have to be replaced.

Figure 4 LED and Coin Counter Addresses

ADDRESS	ON-DATA	OFF-DATA	OUTPUT NAME
4000	01	00	Right Coin Counter
4000	02	00	Center Coin Counter
4000	04	00	Left Coin Counter
60E0	FD	FF	1-player start LED
60E0	FE	FF	2-player start LED

H. Analog Vector-Generator

1. Test:

1. Perform CAT Box preliminary set-up.
2. DATA SOURCE: DATA
3. R/W: WRITE
4. R/W MODE: (OFF)
5. Key in address from Figure 5 or press ADDRESS INC.
6. Press DATA SET
7. Key in data from Figure 5
8. Set R/W MODE to PULSE and then to (OFF)
9. Repeat steps 5-8 for each address in Figure 5

CAUTION

You may damage the circuitry of the X-Y monitor if you key in the VG GO signal without first checking all the addresses and data. Check the data by reading each address location using steps 10-14:

10. R/W: READ
11. R/W MODE: (OFF)
12. Key in address or press ADDRESS INC.
13. R/W MODE: PULSE
14. Check the data in the DATA DISPLAY against the data in Figure 5

If you are sure the data is correct, proceed to steps 15-19:

15. R/W MODE: WRITE
16. R/W: (OFF)
17. Key in VG GO address (4800 for TEMPEST™)
18. R/W to PULSE and then back to (OFF)
19. After writing to the VG GO address, the monitor should show a large plus sign. Failure of the horizontal or vertical circuits shows up as a single line drawn on the monitor. *If your monitor does not display a large plus sign, contact Atari Field Service.*

Figure 5 Analog Vector-Generator Data

Address	Data	Address	Data	Address	Data
2000	40	200C	FF	2018	00
2001	80	200D	03	2019	40
2002	00	200E	00	201A	80
2003	70	200F	62	201B	00
2004	00	2010	40	201C	80
2005	1E	2011	80	201D	1F
2006	00	2012	80	201E	00
2007	1E	2013	00	201F	00
2008	00	2014	00	2020	FF
2009	60	2015	00	2021	40
200A	FF	2016	01	2022	00
200B	03	2017	1F	2023	E0

4 Troubleshooting



With Signature Analysis

A. Signature Analysis Set-up

1. Perform the CAT Box Preliminary set-up.
2. Connect the three BNC to E-Z clip cables (supplied with the CAT Box) to the SIGNATURE ANALYSIS CONTROL START, STOP and CLOCK jacks on the CAT Box.
3. Attach the three black E-Z clips to a ground loop on the Tempest™ game PCB.
4. Attach the CAT Box data probe to the DATA jack on the CAT Box.
5. The colored E-Z clips on the cables will be moved about for each group of signatures to be taken.
6. Set the CAT Box switches as follows:
 - TESTER MODE: SIG
 - TESTER SELF-TEST: OFF
 - PULSE MODE: LATCHED
 - START: As indicated
 - STOP: As indicated
 - CLOCK: As indicated
7. Power up the game board and the CAT Box.

B. Address Lines

1. CAT Box Settings for Address Bus Test

Probe	Trigger	IC-Pin	Test Pt.
Start		A6-3	
Stop		A6-3	
Clock		C2-39	φ2

Verify CAT Box settings and connections as follows:

- probe GND test point = 0000 signature
- probe +5V test point = 0001 signature



2. Signatures

Logic Probe on IC-Pin	Signal Name	Signature Should Be
B/C1-12	AB0	UUUU
B/C1-14	AB1	5555
B/C1-16	AB2	CCCC
B/C1-18	AB3	7F7F
B/C1-9	AB4	5H21
B/C1-7	AB5	0AFA
B/C1-5	AB6	UPFH
B/C1-3	AB7	52F8
A/B1-12	AB8	HC89
A/B1-14	AB9	2H70
A/B1-16	AB10	HPP0
A/B1-18	AB11	1293
A/B1-3	AB12	HAP7
B3-2	A13	3C96
B3-3	A14	3827
B3-1	A15	755U
A6-4	A15	755P

C. Address Decoder

NOTE: While testing decoders and ROMs, it may be necessary to add 270 pF capacitors to ADDR 12, 13, 14 and 15 to eliminate unstable signatures.

1. CAT Box Settings for Address Decoder Test



Probe	Trigger	IC-Pin	Test Pt.
Start		A6-3	
Stop		A6-3	
Clock			φ 2

2. Signatures

NOTE: To obtain Signatures from IC J5, ground R/W testpoint.

Logic Probe on IC-Pin	Signal Name	Signature Should Be
B3-7	I/O	F2A6
E3-2	I/O	F2A7
F3-8	EI/O	F2A6
J5-9	VGRST	5969
J5-10	WDCLR	0PC5
J5-11	VGGO	270P
J5-12	BB*	9CH2
B3-5	VMEM	12U3
B3-4	AA*	4P0A
J2-7	ROM8	56C3
J2-6	ROM7	8019
J2-5	ROM6	5AH1
J2-4	ROM5	9HUC
J2-9	ROM4	1920
J2-10	ROM3	C34C
J2-11	ROM2	597C
J2-12	ROM1	UA87
C1-7	ROM0	4154
C1-6	ROMX	960F

3. CAT Box Settings for Address Decoder Test

Probe	Trigger	Testpoint
Start		A6-4
Stop		A6-4
Clock		φ2

4. Signatures

Verify CAT Box setting and connections as follows: probe +5V = 755U signature.



Logic Probe on IC-Pin	Signature Should Be
B3-9	970C
B3-10	868C
B3-11	7FF8
B3-12	1817

D. ROM and Data Lines

NOTE: When taking signatures on ROMs, install a 270 pF capacitor between IC B3, Pin 2 and ground.

1. CAT Box Settings for ROMX Test

(I.C. D1 for ROM part no. 136002-101, -113 or -133.)



Probe	Trigger	Testpoint
Start		$\overline{\text{ROMX}}$
Stop		$\overline{\text{ROMX}}$
Clock		$\phi 2$

2. Signatures

Logic Probe on IC-Pin	Signal Name	Signature Should Be
D1-9	DB0	1F4H
D1-10	DB1	4P55
D1-11	DB2	P2C5
D1-13	DB3	UH32
D1-14	DB4	4HFA
D1-15	DB5	0P76
D1-16	DB6	86CP
D1-17	DB7	P29C

3. CAT Box Settings for ROM0 Test

(I.C. E1 for ROM part no. 136002-102 or -114.
I.C. D1 for ROM part no. 136002-133.)

Probe	Trigger	Testpoint
Start		$\overline{\text{ROM0}}$
Stop		$\overline{\text{ROM0}}$
Clock		$\phi 2$



4. Signatures

Verify CAT Box settings and connections as follows:
probe +5V = 7A70 signature.

Logic Probe on IC-Pin	Signal Name	Signature Should Be
E1-9	DB0	6481
E1-10	DB1	P6A9
E1-11	DB2	9552
E1-13	DB3	40F3
E1-14	DB4	37C2
E1-15	DB5	0A18
E1-16	DB6	A2C0
E1-17	DB7	9HC5

5. CAT Box Settings for ROM1 Test

(I.C. F1 for ROM part no. 136002-103, 115 or -134.)

Probe	Trigger	Testpoint
Start		$\overline{\text{ROM1}}$
Stop		$\overline{\text{ROM1}}$
Clock		$\phi 2$



6. Signatures

Verify CAT Box settings and connections as follows:
probe +5V = 7A70 signature.

Logic Probe on IC-Pin	Signal Name	Signature Should Be
F1-9	DB0	3892
F1-10	DB1	01U5
F1-11	DB2	PH6P
F1-13	DB3	UP9F
F1-14	DB4	UP44
F1-15	DB5	CA33
F1-16	DB6	3U05
F1-17	DB7	8CP3

7. CAT Box Settings for ROM2 Test

(I.C. H1 for ROM part no. 136002-104 or -116.
I.C. F1 for ROM part no. 136002-134.)

Probe	Trigger	Testpoint
Start		$\overline{\text{ROM2}}$
Stop		$\overline{\text{ROM2}}$
Clock		$\phi 2$

8. Signatures

Verify CAT Box settings and connections as follows:
probe +5V = 7A70 signature.

Logic Probe on IC-Pin	Signal Name	Signature Should Be
H1-9	DB0	7550
H1-10	DB1	A01F
H1-11	DB2	A540
H1-13	DB3	5U60
H1-14	DB4	2068
H1-15	DB5	9767
H1-16	DB6	54CA
H1-17	DB7	7F8F

9. CAT Box Settings for ROM3 Test

(I.C. J1 for ROM part no. 136002-105, -117 or -135.)

Probe	Trigger	Testpoint
Start		$\overline{\text{ROM3}}$
Stop		ROM3
Clock		$\phi 2$

10. Signatures

Verify CAT Box settings and connections as follows:
probe +5V = 7A70 signature.

Logic Probe on IC-Pin	Signal Name	Signature Should Be
J1-9	DB0	09A6
J1-10	DB1	6A12
J1-11	DB2	91CA
J1-13	DB3	10HP
J1-14	DB4	F53U
J1-15	DB5	C67C
J1-16	DB6	8272
J1-17	DB7	F651

13. CAT Box Settings for ROM5 Test

(I.C. L/M1 for ROM part no. 136002-107, -119 or -136.)

Probe	Trigger	Testpoint
Start		$\overline{\text{ROM5}}$
Stop		ROM5
Clock		$\phi 2$

14. Signatures

Verify CAT Box settings and connections as follows:
probe +5V = 7A70 signature.

Logic Probe on IC-Pin	Signal Name	Signature Should Be
L/M1-9	DB0	4876
L/M1-10	DB1	5397
L/M1-11	DB2	7396
L/M1-13	DB3	C9CH
L/M1-14	DB4	HF73
L/M1-15	DB5	11U6
L/M1-16	DB6	43C8
L/M1-17	DB7	2P85

11. CAT Box Settings for ROM4 Test

(I.C. K1 for ROM part no. 136002-106 or -118.
I.C. J1 for ROM part no. 136002-135.)

Probe	Trigger	Testpoint
Start		$\overline{\text{ROM4}}$
Stop		ROM4
Clock		$\phi 2$

12. Signatures

Verify CAT Box settings and connections as follows:
probe +5V = 7A70 signature.

Logic Probe on IC-Pin	Signal Name	Signature Should Be
K1-9	DB0	A8FU
K1-10	DB1	U3U7
K1-11	DB2	C8CH
K1-13	DB3	353F
K1-14	DB4	93FU
K1-15	DB5	UFH1
K1-16	DB6	A165
K1-17	DB7	5399

15. CAT Box Settings for ROM6 Test

(I.C. M/N1 for ROM part no. 136002-108 or -120.
I.C. L/M1 for ROM part no. 136002-136.)

Probe	Trigger	Testpoint
Start		$\overline{\text{ROM6}}$
Stop		ROM6
Clock		$\phi 2$

16. Signatures

Verify CAT Box settings and connections as follows:
probe +5V = 7A70 signature.

Logic Probe on IC-Pin	Signal Name	Signature Should Be
M/N-9	DB0	A4AC
M/N-10	DB1	3A7C
M/N-11	DB2	0F22
M/N-13	DB3	H221
M/N-14	DB4	2H07
M/N-15	DB5	818A
M/N-16	DB6	1699
M/N-17	DB7	4149

17. CAT Box Settings for ROM7 Test

(I.C. P1 for ROM part no. 136002-109, -121 or -137.)

Probe	Trigger	Testpoint
Start		$\overline{\text{ROM7}}$
Stop		$\overline{\text{ROM7}}$
Clock		$\phi 2$

18. Signatures

Verify CAT Box settings and connections as follows: probe +5V = 7A70 signature.

Logic Probe on IC-Pin	Signal Name	Signature Should Be
P1-9	DB0	P4F3
P1-10	DB1	2C06
P1-11	DB2	4614
P1-13	DB3	7A63
P1-14	DB4	434C
P1-15	DB5	3C66
P1-16	DB6	P8U6
P1-17	DB7	2C3A

19. CAT Box Settings for ROM8 Test

(I.C. R1 for ROM part no. 136002-110 or -122.
I.C. P1 for ROM part no. 136002-137.)

Probe	Trigger	Testpoint
Start		$\overline{\text{ROM8}}$
Stop		$\overline{\text{ROM8}}$
Clock		$\phi 2$

20. Signatures

Verify CAT Box settings and connections as follows: probe +5V = 7A70 signature.

Logic Probe on IC-Pin	Signal Name	Signature Should Be
R1-9	DB0	9HFP
R1-10	DB1	U7HH
R1-11	DB2	F32H
R1-13	DB3	F66U
R1-14	DB4	U379
R1-15	DB5	490P
R1-16	DB6	5P99
R1-17	DB7	CFA8

21. CAT Box Settings for Vector

ROM Test (I.C. N/P3 for part no. 136002-111, -123 or -138.)

NOTE: When taking signatures on IC N/P3, ground IC-Pin B3-5.

Probe	Trigger	IC-Pin	Testpoint
Start		C1-10	
Stop		C1-10	
Clock			$\phi 2$

22. Signatures

Verify CAT Box settings and connections as follows: probe +5V = 7A70 signature.

Logic Probe on IC-Pin	Signal Name	Signature Should Be
N/P3-9	DB0	H1U9
N/P3-10	DB1	5U8C
N/P3-11	DB2	0C59
N/P3-13	DB3	507P
N/P3-14	DB4	2A8P
N/P3-15	DB5	9F0C
N/P3-16	DB6	AH97
N/P3-17	DB7	29AH

23. CAT Box Settings for Vector

ROM1 Test (I.C. R3 for part no. 136002-112 or -124.)

NOTE: When taking signatures on I.C. R3, ground IC-Pin B3-5.

Probe	Trigger	IC-Pin	Testpoint
Start		C1 Pin 9	
Stop		C1 Pin 9	
Clock			$\phi 2$

24. Signatures

Logic Probe on IC-Pin	Signal Name	Signature Should Be
R3-9	DB0	3FH3
R3-10	DB1	0H59
R3-11	DB2	9H5H
R3-13	DB3	98PF
R3-14	DB4	PA27
R3-15	DB5	5U3H
R3-16	DB6	97FC
R3-17	DB7	583A

E. Math Box

The Math Box signature analysis procedure is somewhat different from other procedures, so follow these set-up instructions for the three tests carefully.

In addition to your CAT Box or signature analyzer, you'll need an SA Harness Assembly. Order Atari part number A036836-01 or see Figure 6 to make your own.

A. Math Box Test #1 Procedure:

1. Plug SA Harness Assembly Test #1 connector onto Signature Analyzer connector (J16) on the Auxiliary PCB.
2. Connect the CAT Box Start, Stop and Clock E-Z hooks to the SA Harness Assembly as shown in Figure 7.
3. On the main PCB, connect PWR ON RESET test point to ground, and power-up the game and the CAT Box.
4. Don't remove the microprocessor (6502A) from the main PCB.

Don't connect the 50 pin ribbon cable to the main PCB edge connector.

Don't connect W DOG DIS to ground.

5. Set the CAT Box switches as follows:

- a. START
- b. STOP
- c. CLOCK
- d. TESTER MODE: SIG
- e. Press TESTER RESET

6. With the logic probe touching the +5V test point on the Auxiliary PCB, the ADDRESS/SIGNATURE display should read CC34. This will verify that your test set-up is correct. If you don't get CC34, recheck your set-up.

NOTE: Signatures are listed in the order that they should be done. As often as possible, *IC-Pin* refers to a chip output. As a general rule, when a bad signature is discovered, the IC listed in the *IC-Pin* column can be suspected as faulty.

Those signatures marked with an asterisk (*) should be taken with a 1K resistor clipped between the logic probe and the +5V test point.

Figure 6 S.A. Harness Assembly

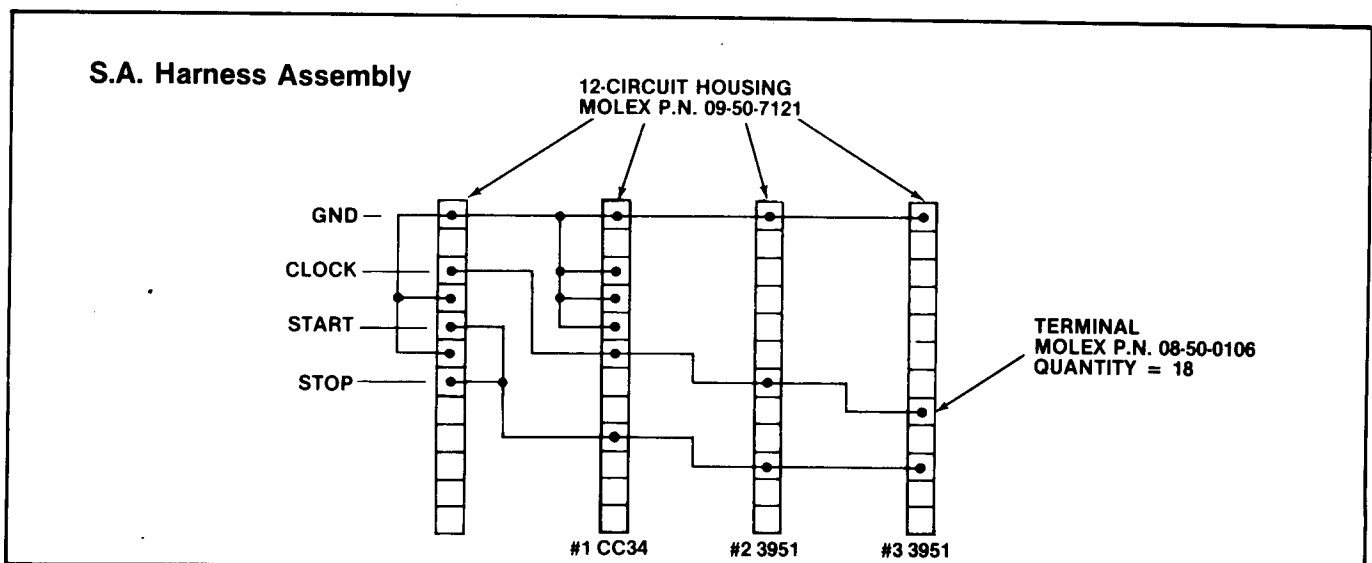

Signatures

*Logic Probe
on IC-Pin*

*Signature
Should Be*

C1-11	H58A
C1-12	77F7
C1-13	85PA
C1-14	7P25
D1-11	5CP0
D1-12	P5PH
D1-13	725C
D1-14	96PF
F1-12	4PPF
F1-11	OUF0
F1-10	3CAP
F1-9	A6A3
H1-12	26A6
H1-11	91HA
H1-10	P9C1
H1-9	2987
J1-12	96U0
J1-11	UC59
J1-10	6989
J1-9	3FU4
K1-12	05A6
K1-11	60H6
K1-10	PPF6
K1-9	34C2
L1-12	58A1
L1-11	1AA2
L1-10	F74F
L1-9	6CF6
E1-12	F765
E1-11	CPU8
E1-10	0000
E1-9	F515
F4-2	CC34
E4-6	A6A3
A2-6	0000
B1-2	8A7H
B1-5	CU2P
B1-6	1C6C
B1-9	6U30
B1-12	5AAH
B1-15	03A7
B1-16	9A08
B1-19	2327
K/L2-33	6PUP
K/L2-16	9AFH*
K/L2-8	809A*
F/H2-33	9CPP
F/H2-16	11C5*

F/H2-8

J2-33

J2-16

J2-8

E2-34

E2-31

E2-16

E5-11

D4-8

E4-11

F5-11

D4-6

F5-6

E4-8

E5-8

78AA*

8631

11C5*

7U19*

A1F7

1781

9AFH*

C646

0600

CC34

C835*



C4U4

753F

CPU8

45A1*

**B. Math Box Test #2A
Procedure**

1. Plug SA Harness Assembly Test #2 connector on-to Signature Analyzer connector (J16) on the Auxiliary PCB.
2. Connect the CAT Box Start, Stop and Clock E-Z hooks to the SA Harness Assembly as shown in Figure 7.
3. Don't remove the microprocessor (6502A) from the main PCB.
Don't connect the 50 pin ribbon cable to the main PCB edge connector.
Don't connect W DOG DIS to ground.
Don't connect PWR ON RESET to ground.
4. Set the CAT Box switches as follows:
 - a. START 
 - b. STOP 
 - c. CLOCK 
 - d. TESTER MODE: SIG
 - e. Press TESTER RESET
5. Enter the self-test mode and advance the screen with the slam switch until the large blank rectangle appears. This procedure is described in Figure 6, Chapter 2 of the Tempest™ Operation, Maintenance, and Service Manual.
6. With the logic probe touching the +5V test point on the Auxiliary PCB, the ADDRESS/SIGNATURE display should read 3951. This will verify that your test set-up is correct. If you don't get 3951, re-check your set-up.

NOTE: Signatures are listed in the order that they should be done. As often as possible, *IC-Pin* refers to a chip output. As a general rule, when a bad signature is discovered, the IC listed in the *IC-Pin* column can be suspected as faulty.

Signatures

Logic Probe on IC-Pin	Signature Should Be
A1-14	F722
A1-13	C4P5
A1-12	6UAC
A1-11	3441
A1-10	2P61
A1-9	92F3
A1-7	A856
A1-6	3050
A1-5	H8F9
A1-4	9569
A1-3	3U53
A1-2	9F47
A1-1	4FUF

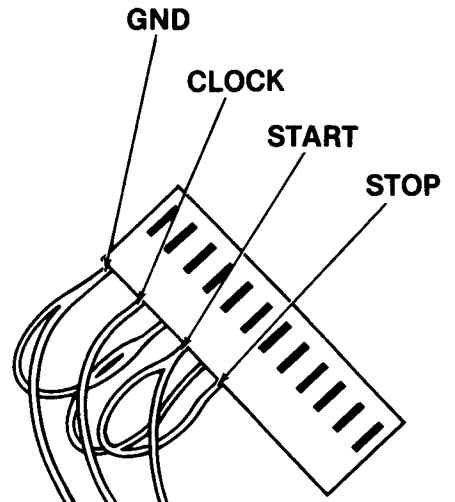

A036836-01

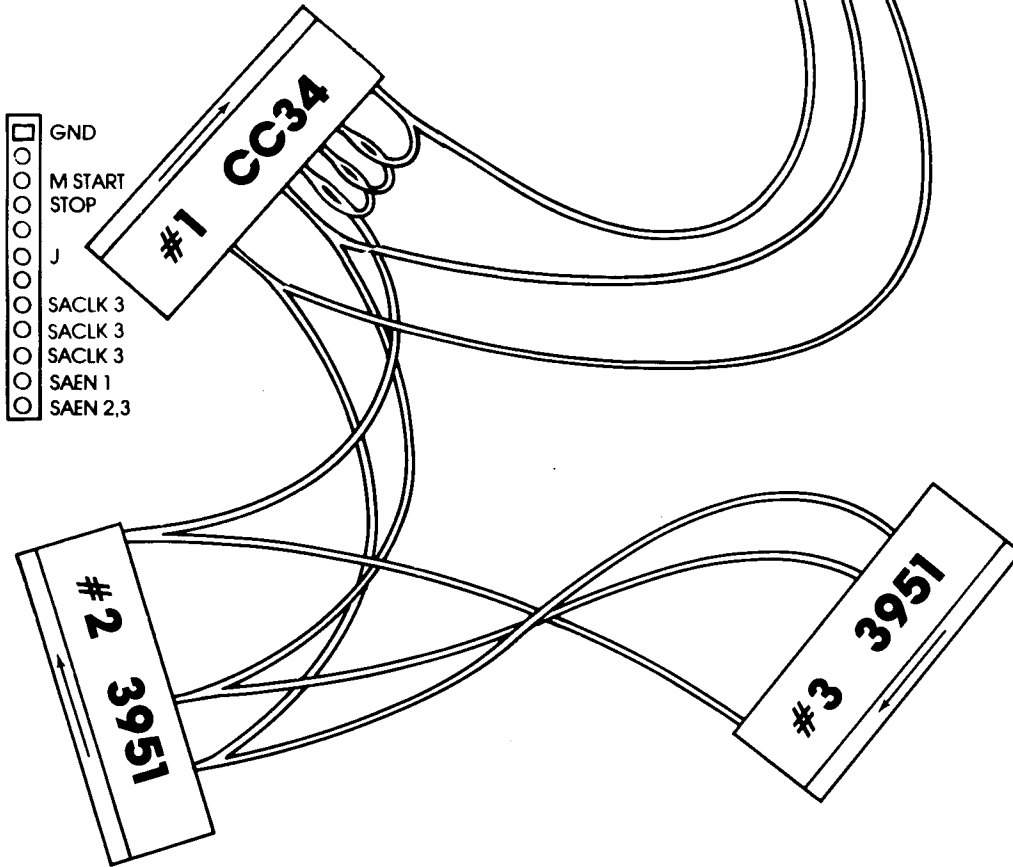





Figure 7 S.A. Harness Assembly

C. Math Box Test #2B Procedure



1. Plug SA Harness Assembly Test #2 connector on-to Signature Analyzer connector (J16) on the Auxiliary PCB.
2. Connect the CAT Box Start, Stop and Clock E-Z hooks to the SA Harness Assembly as shown in Figure 7.
3. Don't remove the microprocessor (6502A) from the main PCB.
Don't connect the 50 pin ribbon cable to the main PCB edge connector.
Don't connect W DOG DIS to ground.
Don't connect PWR ON RESET to ground.
4. Set the CAT Box switches as follows:
 - a. START 
 - b. STOP 
 - c. CLOCK 
 - d. TESTER MODE: SIG
 - e. Press TESTER RESET
5. Enter the self-test mode and advance the screen with the slam switch until the large blank rectangle appears. This procedure is described in Figure 6, Chapter 2 of the Tempest™ Operation, Maintenance, and Service Manual.
6. With the logic probe touching the +5V test point on the Auxiliary PCB, the ADDRESS/SIGNATURE display should read 3951. This will verify that your test set-up is correct. If you don't get 3951, recheck your set-up.

NOTE: Signatures are listed in the order that they should be done. As often as possible, *IC-Pin* refers to a chip output. As a general rule, when a bad signature is discovered, the IC listed in the *IC-Pin* column can be suspected as faulty.

Signatures

Logic Probe on IC-Pin	Signature Should Be
C1-11	92F3
C1-12	A856
C1-13	3050
C1-14	H8F9
D1-11	9569
D1-12	3U53
D1-13	9F47
D1-14	4FUF

D. Math Box Test #3 Procedure

1. Plug SA Harness Assembly Test #3 connector on-to Signature Analyzer connector (J16) on the Auxiliary PCB.
2. Connect the CAT Box Start, Stop and Clock E-Z hooks to the SA Harness Assembly as shown in Figure 7.
3. Don't remove the microprocessor (6502A) from the main PCB.
Don't connect the 50 pin ribbon cable to the main PCB edge connector.
Don't connect W DOG DIS to ground.
Don't connect PWR ON RESET to ground.
4. Set the CAT Box switches as follows:
 - a. START 
 - b. STOP 
 - c. CLOCK 
 - d. TESTER MODE: SIG
 - e. Press TESTER RESET
5. Enter the self-test mode and advance the screen with the slam switch until the large blank rectangle appears. This procedure is described in Figure 6, Chapter 2 of the Tempest™ Operation, Maintenance, and Service Manual.
6. With the logic probe touching the +5V test point on the Auxiliary PCB, the ADDRESS/SIGNATURE display should read 3951. This will verify that your test set-up is correct. If you don't get 3951, recheck your set-up.

NOTE: Signatures are listed in the order that they should be done. As often as possible, *IC-Pin* refers to a chip output. As a general rule, when a bad signature is discovered, the IC listed in the *IC-Pin* column can be suspected as faulty.

Signatures

Logic Probe on IC-Pin	Signature Should Be
E2-22	1441
E2-23	2883
E2-24	5107
E2-25	A20P
J2-22	441H
J2-23	883A
J2-24	1074
J2-25	20P9



ATARI INC
1265 BORREGAS AVENUE
P.O. BOX 427
SUNNYVALE, CALIFORNIA 94086
408/745-2000 • TELEX 35-7488

 A Warner Communications Company