

REV	REVISIONS DESCRIPTION	DATE	APPROVED
3	ENG REL PER ERC# E0481	4/3/84	JW
4	INCORPORATED PER ERC E0481	4/4/84	JW

ENGINEERING RELEASED

	1450XLD	DRAWN BY <i>R. Alister</i>	DATE <i>3/2/84</i>	 ATARI <small>Warner Communications Company</small>	Atari, Inc. 30 E. Plumaria Drive San Jose, CA 95134					
NEXT ASSY	USED ON	CHECKED <i>R. Alister</i>	DATE <i>3/2/84</i>							
NOTICE TO ALL PERSONS RECEIVING THIS DRAWING CONFIDENTIAL: Reproduction Forbidden without the specific written permission of Atari Inc., Sunnyvale, California. This drawing is only conditionally issued, and neither receipt nor possession thereof conveys or transfers any right in, or license to use, the subject matter of the drawing or any design or technical information shown thereon, nor any right to reproduce this drawing or any part thereof, except for manufacture by vendors of Atari Incorporated and for manufacture under the corpora- tion's written license, no right to reproduce this drawing is granted or the subject matter thereof unless by written agree- ment with or written permission from the corporation.				TITLE GATE ARRAY "CARMEN"						
				ENGINEER <i>R. Alister</i>	DATE <i>3/2/84</i>	APPROVED <i>JW</i>	DATE <i>4/1/84</i>	SIZE A	DRAWING NO. C025338-001	REV <i>1</i>
				APPROVED <i>JW</i>	DATE <i>4/1/84</i>	SCALE		SHEET 1 OF 14		

INDEX

- 1.0 SCOPE
- 2.0 APPLICABLE DOCUMENTS
- 3.0 DEVIATIONS
- 4.0 PRECEDENCE
- 5.0 GENERAL REQUIREMENTS
 - 5.1 ELECTROSTATIC DISCHARGE
 - 5.2 MARKING
 - 5.3 BLOCK DIAGRAM
 - 5.4 PACKAGE DESCRIPTION
 - 5.5 LEAD INTEGRITY AND SOLDERABILITY
- 6.0 ABSOLUTE MAXIMUM RATINGS
 - 6.1 SUPPLY VOLTAGE
 - 6.2 VOLTAGE APPLIED TO ANY INPUT
 - 6.3 VOLTAGE APPLIED TO ANY OUTPUT
 - 6.4 POWER DISSIPATION
 - 6.5 JUNCTION TEMPERATURE
 - 6.6 OPERATING TEMPERATURE
 - 6.7 STORAGE TEMPERATURE
- 7.0 STATIC CHARACTERISTICS
 - 7.1 INPUT VOLTAGE HIGH
 - 7.2 INPUT VOLTAGE LOW
 - 7.3 INPUT CURRENT
 - 7.4 OUTPUT VOLTAGE HIGH
 - 7.5 OUTPUT VOLTAGE LOW
 - 7.6 OUTPUT LEAKAGE CURRENT HIGH
 - 7.7 OUTPUT LEAKAGE CURRENT LOW
 - 7.8 POWER SUPPLY CURRENT
 - 7.9 BREAKDOWN VOLTAGE
- 8.0 DYNAMIC CHARACTERISTICS
 - 8.1 INPUT TO OUTPUT PROP. DELAY
 - 8.2 CLOCK WIDTH
- 9.0 DYNAMIC TEST WAVEFORMS
 - 9.1 TIMING DEFINITIONS
 - 9.2 TIMING DIAGRAMS
- 10.0 DYNAMIC TEST SET-UP
 - 10.1 LOAD CIRCUIT FOR OUTPUT PINS
 - 10.2 INPUT PULSE DEFINITIONS
- 11.0 GATE ARRAY LOGIC EQUATIONS
- 12.0 ELECTRICAL CHARACTERIZATION TESTING
- 13.0 Pin Assignment



 A Warner Communications Company

Atari, Inc.
30 E. Plumeria Drive
San Jose, CA 95134

SIZE	DRAWING NO.	REV
	C025338-001	4
SCALE	SHEET 2 OF 14	

1.0 SCOPE

This document is a preliminary specification of the electrical and mechanical requirements for a 40 pin custom high speed CMOS gate array I.C. device designated for use on the "TONG" project. The device is currently under development and there may be revisions to this document before it is Production Released.

2.0 APPLICABLE DOCUMENTS

The following documents, at the revision which is in effect on the date of the Purchase Order, shall form part of this specification to the extent referenced herein.

- a. CO99901 - Qualification and Reliability Requirements for Integrated Circuits and Discrete Semiconductors.
- b. CO99902 - Handling of Devices Susceptible to Static Discharge.
- c. CO99905 - External Visual and Solderability Requirements.
- d. CO99906 - Internal Visual Requirements for Atari Semiconductors.
- e. CO21538 - Electrostatic Discharge Sensitivity Testing.
- f. CO99931 - Dual In-Line Package, General Specifications.

3.0 DEVIATIONS

Product sold to Atari, Inc. under this specification must be identical to original approved samples. Any changes to the product must receive Atari, Inc. sample reapproval prior to delivery. Any deviation from this specification, or from any of the above listed applicable documents, must be approved in writing through the current Atari Deviation Procedure prior to any deviation taking place.

4.0 PRECEDENCE

This specification, including all approved deviations, shall be the governing document for device acceptance. In the event of conflict between this document and any other document, contract, specification or requirement, the manufacturer is responsible to notify Atari, Inc. for written disposition from the affected functional group(s), as identified within this document.

5.0 GENERAL REQUIREMENTS

5.1 ELECTROSTATIC DISCHARGE

Parts must conform to the requirements of the Atari, Inc. Specification #CO21538, Electrostatic Discharge Sensitivity Testing.



 A Warner Communicator's Company

Atari, Inc.
30 E. Plumeria Drive
San Jose, CA 95134

SIZE	DRAWING NO. C025338-001	REV 4
SCALE	SHEET 3 OF 14	

5.2 MARKING

Minimally, parts must be marked permanently and legibly as per Atari, Inc. Specification #C099901 para. 10.1.12 with:

- a. Atari Part Number
- b. Date Code
- c. Copyright Symbol and information:
 - © ATARI (Year); year must be represented as either the full year (e.g. 1983) or the last two digits (e.g. 83)
- d. Vendor or industry recognized identification symbol
- e. Pin #1 Identification

5.3 BLOCK DIAGRAM

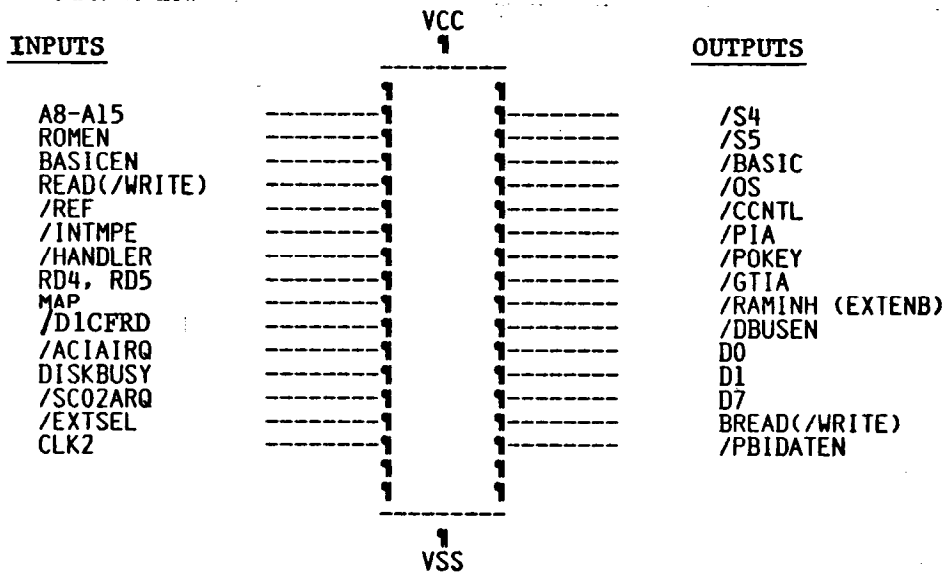

NOTE: See Section 13.0 for pin assignment.



Atari, Inc.
30 E. Plumeria Drive
San Jose, CA 95134

SIZE

DRAWING NO.

C025338-001

REV

4

5.4 PACKAGE DESCRIPTION

Package shall be void-free plastic.

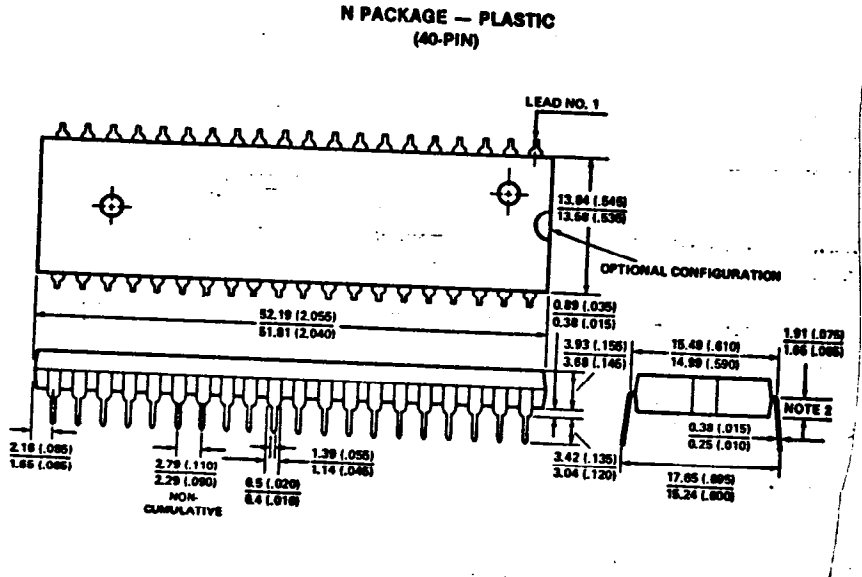

5.5 LEAD INTEGRITY AND SOLDERABILITY

As per Atari, Inc. Specification #C099901, para. 10.1.11 Lead Integrity and 10.1.16 Solderability.

	Atari, Inc. 30 E. Plumaria Drive San Jose, CA 95134		SIZE DRAWING NO. C025338-001	REV 4
	SCALE		SHEET 5 OF 14	

6.0 ABSOLUTE MAXIMUM RATINGS

Limits beyond which the life of the part may be impaired. It is **NOT** implied that the device should be operated at these limits. If the part is operated at or near these limits, applicable manufacturers' derating calculations must be imposed.

ITEM	CHARACTERISTIC	LIMITS	UNITS
6.1	SUPPLY VOLTAGE V_{cc} TO GND (V_{cc})	-0.5 TO +7.0	V
6.2	VOLTAGE APPLIED TO ANY INPUT (V_{ai})	-0.5 TO +7.0	V
6.3	VOLTAGE APPLIED TO ANY OUTPUT (V_{ao})	-0.5 TO +7.0	V
6.4	POWER DISSIPATION (P_d)	75	mW
6.5	JUNCTION TEMP. $T_a=70^\circ$ (T_j)	TBD	$^\circ\text{C}$
6.6	OPERATING TEMPERATURE (T_a)	0 TO 70	$^\circ\text{C}$
6.7	STORAGE TEMPERATURE (T_{stj})	-55 TO +150	$^\circ\text{C}$



Atari, Inc.
30 E. Plumeria Drive
San Jose, CA 95134

A Warner Communications Company

SIZE

DRAWING NO.

C025338-001

REV

4

SCALE

SHEET 6 OF 14

7.0 STATIC CHARACTERISTICS

Unless otherwise specified:

- a. $0 \leq T_a \leq 70^\circ\text{C}$
- b. $4.75 \leq V_{cc} \leq 5.25$
- c. Positive current flows into the device
- d. $C_{LOAD} = 50\text{pF}$

ITEM	CHARACTERISTICS	CONDITION	LIMITS		UNITS
			min	max	
7.1	INPUT VOLTAGE HIGH (VIH)		2.0	Vcc	V
7.2	INPUT VOLTAGE LOW (VIL)		-0.3	0.8	V
7.3	INPUT CURRENT (I_I)	$0 \leq V_{in} \leq 5.25$ $V_{cc} = 5.25$	-10	10	μA
7.4	OUTPUT VOLTAGE HIGH (VOH)	$V_{cc} = 4.75$ $I_{OH} = -100\mu\text{A}$	2.4	5.0	V
7.5	OUTPUT VOLTAGE LOW (VOL)	$V_{cc} = 4.75$ $I_{OL} = 1.6 \text{ mA}$	0	0.4	V
7.6	OUTPUT LEAKAGE CURRENT HIGH (I_{LOH})	HIGH Z OUTPUT $V_O = 5.0$ $V_{cc} = 5.25$	-1.0	1.0	μA
7.7	OUTPUT LEAKAGE CURRENT LOW (I_{LOL})	HIGH Z OUTPUT $V_O = 0.0$ $V_{cc} = 5.25$	-1.0	1.0	μA
7.8	POWER SUPPLY CURRENT (I_{CC})	$V_{cc} = 5.25\text{V}$ ALL INPUTS = Vcc DEVICE IS ACTIVE		14	mA
7.9	BREAKDOWN VOLTAGE (Bv)	$I_{in}=10\mu\text{A}$, ALL OTHER=0V; TEST ALL INPUTS ONE AT A TIME	7		V



Atari, Inc.
30 E. Plumaria Drive
San Jose, CA 95134

A Warner Communications Company

SIZE

DRAWING NO.

REV

C025338-001

4

SCALE

SHEET 7 OF 14

8.0 DYNAMIC CHARACTERISTICS

Unless otherwise specified:

- a. $0^{\circ} \leq T_a \leq 70^{\circ}\text{C}$.
- b. $4.75 \leq V_{cc} \leq 5.25$
- c. All waveforms and dynamic parameters tested at 1 std TTL load/50pF.
- d. Ref dynamic test set up sec 10.0.

ITEM	PARAMETER	SYMBOL	MIN	MAX	UNIT
8.1	Input to Output Prop. Delay Except BREAD	t_{PHL}, t_{PLH}		35 15	ns ns
8.2	Width of Clock High Low	t_w	50 50		ns ns

- e. Ref. timing diagrams Section 9.2

9.0 DYNAMIC TEST WAVEFORMS

9.1 TIMING DEFINITIONS

- a. Rise and Fall times are measured at 10 to 90% of the waveform maximum amplitude.
- b. Applied waveform specifications:
 $t_r = t_f \leq 9\text{ns} \pm 10\%$
- c. All waveforms tested at 1 std TTL load/50pF.



Atari, Inc.
30 E. Plumeria Drive
San Jose, CA 95134

 A Warner Communications Company

SIZE	DRAWING NO. C025338-001	REV 4
SCALE	SHEET 8 OF 14	

9.2 TIMING DIAGRAMS

WAVEFORM FOR INVERTING OUTPUTS

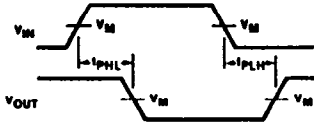

WAVEFORM FOR NON-INVERTING OUTPUTS

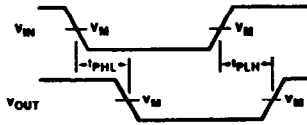

Atari, Inc.
30 E. Plumarla Drive
San Jose, CA 95134

 A Warner Communications Company

SIZE

DRAWING NO.

REV

C025338-001

4

SCALE

SHEET 9 OF 14

10.0 DYNAMIC TEST SET-UP

10.1 LOAD CIRCUIT FOR OUTPUT PINS (or equiv. 1 std TTL load/50pF)

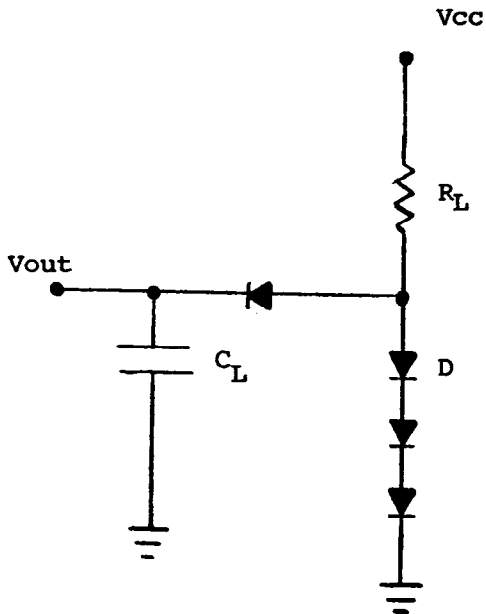

Where: $C_L = 50\text{pF}$
 $R_L = 2\text{K}$
 $D = 1\text{N916, 1N3064 or equivalent}$

10.2 Input Pulse Definitions

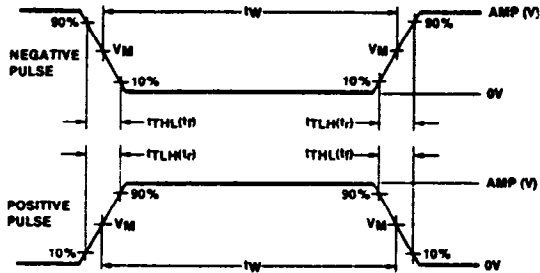

Where: $V_m = 1.5\text{V}$
 Amplitude = 3.0V
 $t_w = 50\text{ns}$
 Repetition rate = 10mhz



Atari, Inc.
 30 E. Plumeria Drive
 San Jose, CA 95134

A Warner Communications Company

SIZE

DRAWING NO.

C025338-001

REV

1/

SCALE

SHEET 10 OF 14

11.0 LOGIC EQUATIONS

 GATE ARRAY "B" 40 PIN PLASTIC ("CARMEN")

 INPUT DEFINITIONS: ("/" DENOTES ACTIVE LOW INPUT)

***** ALL INPUTS ARE DEFINED AS SEEN AT THE INPUT PAD *****

INPUT WITH "*" DENOTES DC LEVEL SIGNALS, WHICH ARE SET DURING PREVIOUS CYCLE.

	+5V	VCC, POWER SUPPLY
	GND	VSS
	A8, A9, A10, A11, A12, A13, A14, A15	ADDRESS BUS
	/REF	/REFRESH
*	ROMEN	ROM ENABLE
*	BASICEN	BASIC ENABLE
*	/INTMPE	/MATH PAK ENABLE
*	RD4, RD5	CARTRIDGE SELECT
*	MAP	SELF TEST ENABLE
*	/HANDLER	PBI HANDLER /CS
	CLK2	CPU PHASE 2 CLOCK
	/D1CFRD	D1CFH/READ
	/ACIAIRQ	/ACIA INTERRUPT REQUEST
*	DISKBUSY	DISK CONTROLLER BUSY
	/SC02ARQ	/SC02 ATTENTION REQUEST
	READ(/WRITE)	CPU READ(/WRITE)
	/EXTSEL	PBI EXTERNAL SELECT
	TOTAL INPUT PIN COUNT:	*** 25 ***



Atari, Inc.
 30 E. Plumeria Drive
 San Jose, CA 95134

A Warner Communications Company

SIZE	DRAWING NO.	REV
	C025338-001	4
SCALE	SHEET 11 OF 14	

 OUTPUT DEFINITIONS: ("/" DENOTES ACTIVE LOW OUTPUT)

***** ALL OUTPUTS ARE DEFINED AS SEEN AT THE OUTPUT PAD *****
 ***** ACTIVE LOW OUTPUTS ARE INVERTED BEFORE GOING TO PAD *****

/S4=	A15*/A14*/A13*RD4*/REF	8000H-9FFFH, CARTRIDGE
/S5=	A15*/A14*A13*RD5*/REF	A000H-BFFFH, CARTRIDGE
/BASIC=	A15*/A14*A13*/RD5*/REF*BASICEN	A000H-BFFFH, BASIC
/OS=	ROMEN*A15*A14*A13*/REF +ROMEN*A15*A14*/A13*/A12*/REF +ROMEN*A15*A14*/A13*A12*A11*INTMPE*/REF +ROMEN*/A15*A14*/A13*A12*/A11*MAP*/REF	E000H-FFFFH, OS C000H-CFFFH, OS D800H-DFFFH, OS MATHPAK 5000H-57FFFH, OS SELFTST
/CCNTL=	A15*A14*/A13*A12*/A11*A10*/A9*A8*/REF	D5XXH, CARTRIDGE CONTRL
/PIA=	A15*A14*/A13*A12*/A11*/A10*A9*A8*/REF	D3XXH, PIA CS
/POKEY=	A15*A14*/A13*A12*/A11*/A10*A9*/A8*/REF	D2XXH, POKEY CS
/GTIA=	A15*A14*/A13*A12*/A11*/A10*/A9*/A8*/REF	DOXXH, GTIA CS
/RAMINH= (EXTENB)	S4 +S5 +BASIC +OS +REF +HANDLER +A15*A14*/A13*A12*/A11*/A10*REF +A15*A14*/A13*A12*/A11*A10*/A9*REF	S4, CARTRIDGE S5, CARTRIDGE BASIC CS OS CS REFRESH PBI HANDLER D000H-D3FFFH, I/O SPACE D400H-D5FFFH, I/O SPACE
/DBUSEN=	POKEY*CLK2 +PIA*CLK2 +BASIC*CLK2 +HANDLER*CLK2 +OS*CLK2 +S4*CLK2 +S5*CLK2 +CCNTL*CLK2	POKEY CS PIA CS BASIC CS PBI HANDLER CS OS CS S4, CARTRIDGE S5, CARTRIDGE CARTRIDGE CONTROL
(IF /D1CFRD = 1)D0=	HIGHZ	TRI-STATED OUTPUT
(IF /D1CFRD = 0)D0=	DISKBUSY	LOGIC OUTPUT
(IF /D1CFRD = 1)D1=	HIGHZ	TRI-STATED OUTPUT
(IF /D1CFRD = 0)D1=	ACIAIRQ	LOGIC OUTPUT
(IF /D1CFRD = 1)D7=	HIGHZ	TRI-STATED OUTPUT
(IF /D1CFRD = 0)D7=	/SCO2ARQ	LOGIC OUTPUT
BREAD(/WRITE)= READ(/WRITE)		BUFFERED READ(/WRITE)
/PBIDATEN=	A15*A14*/A13*A12*/A11*/A10*/A9*A8*/REF*CLK2 +EXTSEL*CLK2 +/READ	D1XXH /EXTSEL TRUE

TOTAL OUTPUT PIN COUNT:

*** 15 ***

TOTAL PIN COUNT FOR GATE ARRAY "B":

*** 40 ***



Atari, Inc.
 30 E. Plumeria Drive
 San Jose, CA 95134

SIZE

DRAWING NO.

C025338-001

REV

4

12.0 ELECTRICAL CHARACTERIZATION TESTING

Characterization and device performance tests are to be done on a Sentry 7 with high voltage test heads.



Atari, Inc.
30 E. Plumarla Drive
San Jose, CA 95134

 A Warner Communications Company

SIZE	DRAWING NO. C025338-001	REV 4
SCALE	SHEET 13 OF 14	

13.0 PIN ASSIGNMENT

<u>Pin #</u>	<u>Signal</u>
1	/HANDLER
2	CLK2
3	/EXTSEL
4	BREAD
5	READ
6	VCC
7	VSS
8	/RAMINH
9	/DBUSEN
10	/PBIDATEN
11	DO
12	DISKBUSY
13	D1
14	/ACIAIRQ
15	/DICFRD
16	D7
17	/SC02ARQ
18	/CCNTL
19	/PIA
20	/POKEY
21	/GTIA
22	ROMEN
23	A8
24	A9
25	A10
26	A11
27	A12
28	A13
29	A14
30	A15
31	/OS
32	MAP
33	RD5
34	RD4
35	/INTMPE
36	/S4
37	/S5
38	BASICEN
39	/REF
40	/BASIC



Atari, Inc.
 30 E. Plumeria Drive
 San Jose, CA 95134

A Warner Communications Company

SIZE	DRAWING NO. C025338-001	REV 4
SCALE	SHEET 14 OF 14	