

A

A

B

B

C

C

D

D

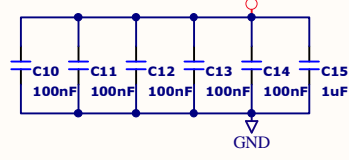
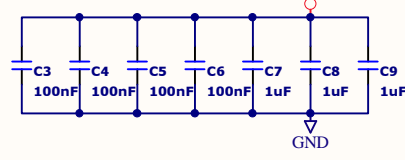
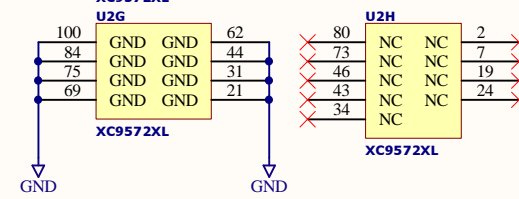
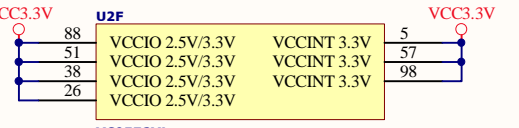
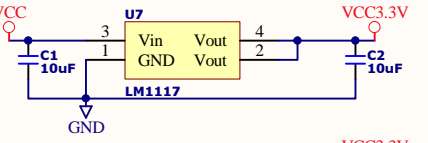
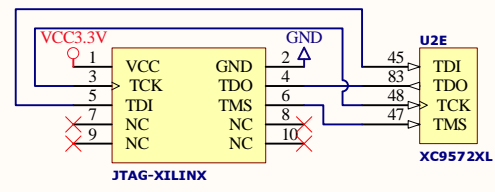
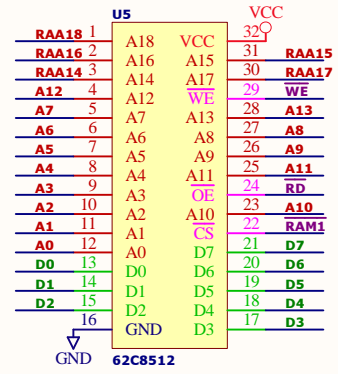
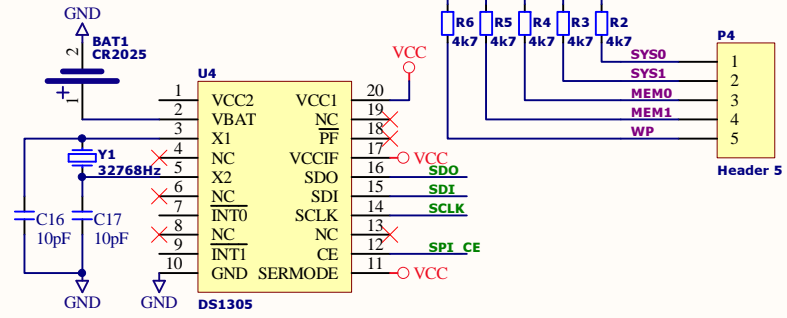
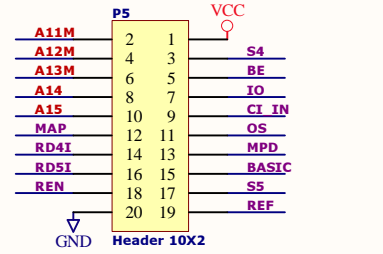
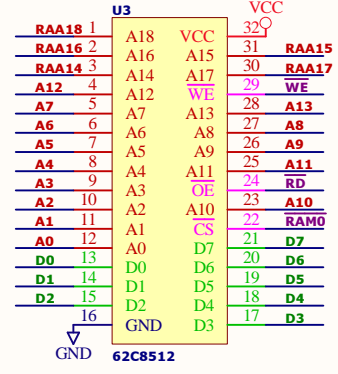
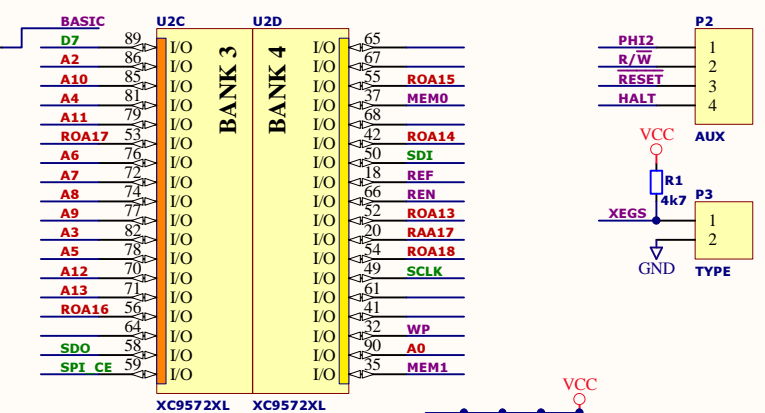
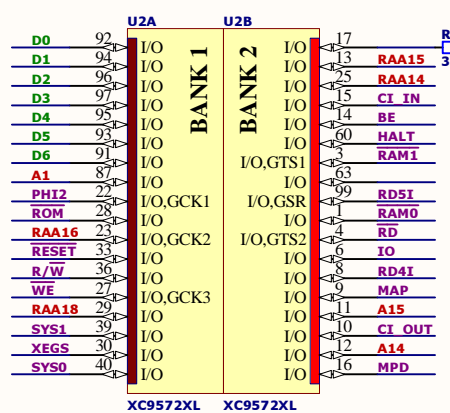
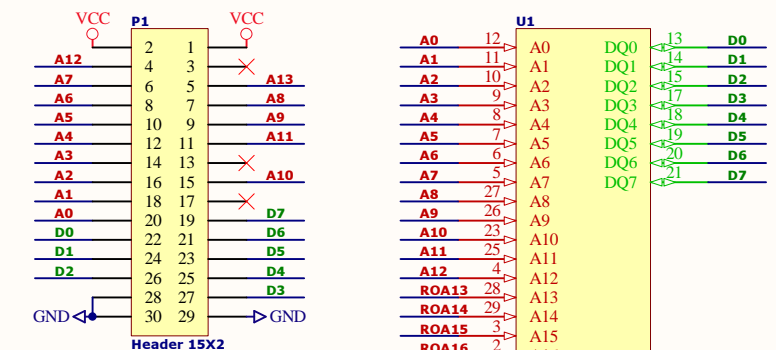

Title		
<b>ULTIMATE1MB</b>		
Size	Number	Revision
A4	1	1
Date:	2011-05-31	Sheet 1 of 1
File:	D:\Private\Ultimate1MB\ultimate.SchDoc	Drawn By: Sebastian Bartkowicz